

<i>General Description</i> .....	D2
<i>Custom Softstarter Panels</i> .....	D4
<b>Series PCS Controllers</b> .....	D6
<i>Selection Guide</i> .....	D8
<i>Accessories</i> .....	D19
<i>Replacement Parts</i> .....	D21
<i>Technical Information &amp; Dimensions (Online)</i> .....	D22
<b>Series PF Controllers</b> .....	D31
<i>Selection Guide</i> .....	D38
<i>Accessories</i> .....	D49
<i>Replacement Parts</i> .....	D50
<i>Technical Information &amp; Dimensions (Online)</i> .....	D51
<b>Series PCEC Hydraulic Elevator Softstarters</b> .....	D58
<i>Selection Guide</i> .....	D60
<i>Replacement Parts</i> .....	D61
<i>Technical Information &amp; Dimensions (Online)</i> .....	D62



# Next Generation Softstarter Intelligent Controllers

From economical to elaborate... the right softstarter for any application up to 1000HP @480V

**D**  
Softstarters



Sprecher + Schuh offers a full line of softstarter controllers that utilize reliable solid state electronics to soft start three phase induction motors. Various options such as “soft-stopping” and braking are also available.

slow-speed with braking. The PF Intelligent controller also features a Pump Control option designed specifically to reduce “waterhammer” in centrifugal pumping applications. Virtually every controller in the line provides a choice of starting and stopping combinations that allow you to create a custom motor controller suited for any application.

## The benefits of controlled starting

Solid state starting reduces the inrush currents and mechanical shock typical of conventional electromechanical motor starters, while providing silent and smooth acceleration without arcing, chattering or vibration. Wear on belts, chains, gearboxes and bearings is reduced, thus minimizing production losses and idle times.

## Modular and Compact Design

As standard, the Sprecher + Schuh Softstarter includes a built-in electronic overload, integral bypass and motor starting capabilities for both star-delta and standard squirrel-cage induction motors, advanced protection and diagnostics in a compact, maintainable, modular, cost-effective package.

## Common Applications

- Material Handling
- Overhead Cranes
- Rock Crushers
- Extruders
- Centrifugal Pumps
- Conveying Systems
- Lumber & Saw Mills
- Ventilators & Blowers
- Compressors
- Stirrers & Mixers
- Transport Systems
- Mills & Kneaders

## Create the ideal start/stop profile for your application

Designed from fractional to 1000HP, Sprecher + Schuh softstarters can easily be configured to provide the desired starting and stopping characteristics. Starting modes range from basic Current Limit starting to “Soft Start with Selectable Kickstart,” and other advanced starting modes offered for the PF controller. Standard stopping modes are Soft-stop and coast-to-rest, other optional advanced stopping modes are available in the PF controller such as Smart Motor Brake, Accu-Stop and

## No maintenance, easy installation

Because there are no moving parts, Softstarter Controllers require no regular maintenance to repair or replace worn out components. All units can be easily integrated into a new system or used to upgrade an existing electromechanical system (across-the-line, autotransformer, part-winding or wye-delta) using the same control circuitry.

100HP

400HP

700HP

1000HP

1400HP



**Line Connected**



**Delta Connected**

### PCS Softstarter Controller

- Microprocessor controller designed for 3-phase motors up to 480A (3...85A DIN-rail mountable)
- Provides three different starting modes and selectable soft stop mode
- Includes built-in electronic overload and bypass contactor
- All models wye-delta compatible (6 lead up to 830A).



**Line Connected**





**Delta Connected**

### PF Softstarter Controller

- Microprocessor controller designed for 3-phase motors or Wye-Delta (6-lead) motors (up to 1,250A; 1,600A Y-D).
- Provides four basic starting modes including soft start, current limit starting and softstart with selectable kickstart and other advanced starting modes.
- Includes electronic overload, integral bypass and advanced protection and diagnostics
- Numerous starting and stopping options available including unique Pump Control option for reducing "waterhammer" in pumping systems, and selectable auxiliary contacts.

## Reduced Voltage Solid State Starters

	 <b>PCS Controller</b> 200...600V 1...480 A	 <b>PF Controller</b> 200...600V 1...1250 A
S = Standard Features O = Optional Features		
<b>Features</b>		
Soft Start	S	S
Kickstart	S	S
Current Limit	S	S
Dual Ramp Start	~	S
Full Voltage	~	S
Soft Stop	S	S
Pump Control	~	O
Preset Slow Speed	~	S
Linear Speed	~	S
Smart Motor Braking	~	O
Accu-Stop	~	O
Slow Speed with Braking	~	O
Motor Protection	S	S
Metering	~	S
Keypad Programming/LCD Display	~	S
Inside Delta Connection	S	S
Product Selection	<b>Page D6</b>	<b>Page D31</b>

D

Softstarters

# Custom Softstarter Panels

Serving Many Industries

**D**  
Custom Softstarters

For your  
**Custom application**  
contact  
[customquotes@sprecherschuh.com](mailto:customquotes@sprecherschuh.com)

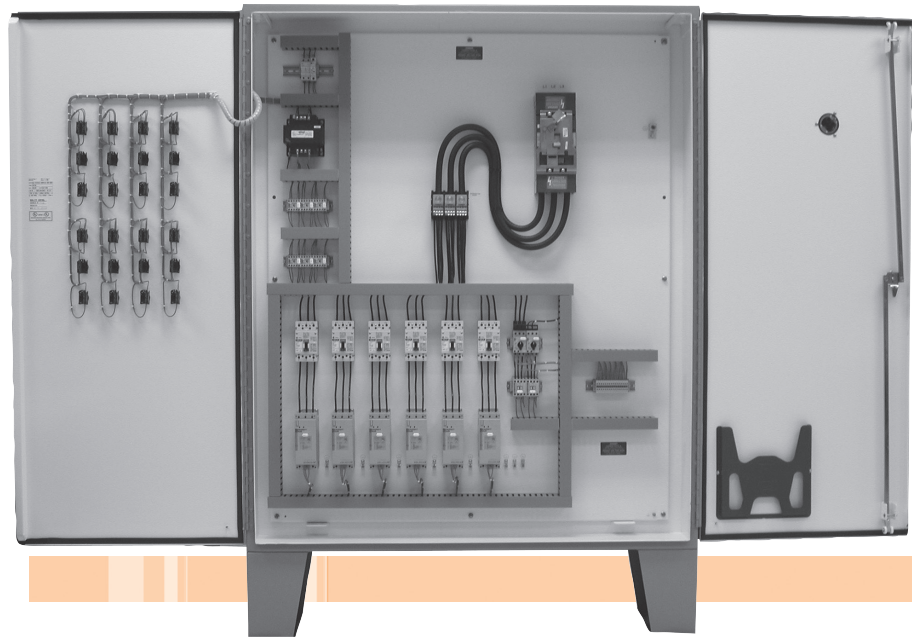

PCS Softstarter Custom Multi-Motor Panel 60HP@480V AC

Sprecher+Schuh offers a broad range of Softstarter products for starting or stopping AC induction motors from ½ Hp to 1000 Hp. The entire range incorporates superior features, such as;

- Three Phase Control
- Built-in electronic overload and integral run bypass for both star-delta and standard squirrel-cage induction motors
- Advanced protection and diagnostics in a compact, maintainable, modular, cost-effective package

many applications. Here is a listing of industries the Sprecher+Schuh Custom Softstarter panels have played a successful role in.

- Food Processing
- Irrigation
- Lumber and Wood Products
- Mining and Metals
- OEM Specialty Machine
- Petrochemical
- Pulp and Paper
- Textile
- Transportation and Machine Tool
- Water/Wastewater Treatment and Municipalities
- Cement/Rock crushers/Chippers

Whether you need a solid state controller for a single motor, special ramping or stopping maneuvers or a complex multi-motor solution, our range of Softstarter controllers meet your required needs for

PFS Softstarter  
• Built-in Overload  
• Built-in Bypass

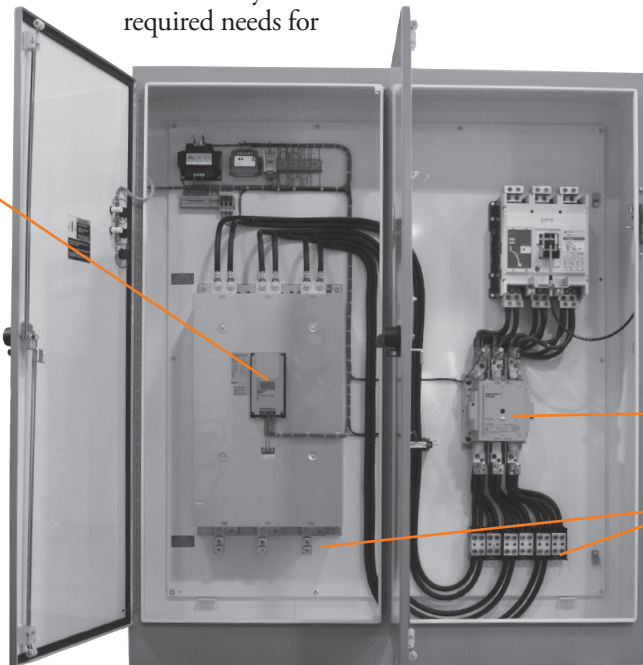

Contact your Sprecher+Schuh motor control and protection representative for consultation regarding custom quotations or help explaining which of the four families of Softstarter best meets your application needs.

Isolation Contactor

Motor Connection Terminals for Wye-Delta 6-Lead Motor

PFS Softstarter  
1000HP@480V AC for  
Wye-Delta 6-Lead Motor

**D4**





PFS Softstarter UL508A Service Entrance  
Custom Panel 150HP@480V AC

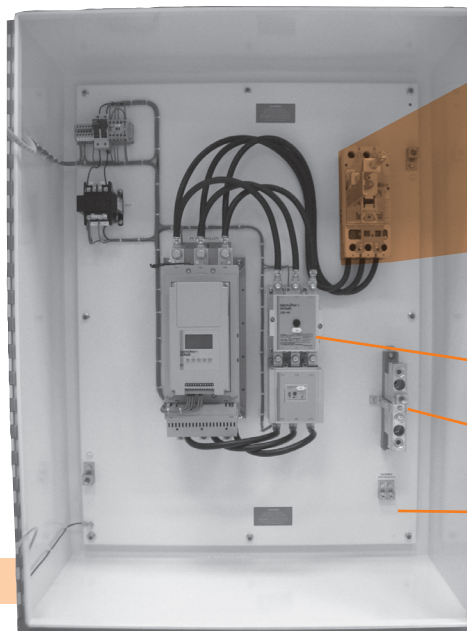

External HP Rated Bypass  
Contactor and Overload

Neutral Terminal

Ground Terminals

## Pumping and Braking Applications

Custom panels using the PCS and PFS Softstarters are an excellent choice for typical motor starting and soft stopping profiles.

For customers seeking a control panel solution to reduce water-hammering or rapid fluid surges, our PFB Pump Control Softstarter is the market leader in this technology. The PFB Softstarter algorithm is specially designed to reduce fluid surges in pumping systems. It provides closed loop acceleration and deceleration control of centrifugal pump motors without the need for feedback devices. When it comes to irrigation, pumping stations or any fluid applications, the PFB Pump Control is the leading choice.

Need to provide a motor control panel to align a tumbler for loading or unloading product? Need to reduce the stopping time of a Bandsaw by more than half of other mechanical braking systems? The PFD Smart Motor Braking is the ideal solution. The PFD Braking option provides motor braking for applications which require the motor to stop quickly. It is a microprocessor based braking system, which applies braking current to a motor. The strength of the braking current is adjustable from 0...400% of full load current.

## UL508A and Service Entrance Labeled

Upon request, custom Softstarter panels can be designed and labeled to meet UL508A requirements and /or Service Entrance requirements. Under UL508A, this ensures that all components in the panel are in compliance with UL and that wire bending spaces and wire sizes are properly selected for the given panel solution. The requirements for Service Entrance is to add special labeling near the main disconnecting handle and include a neutral bar and grounding lugs near the branch circuit protection device. The Sprecher+Schuh team is ready to meet your safety approval specifications.

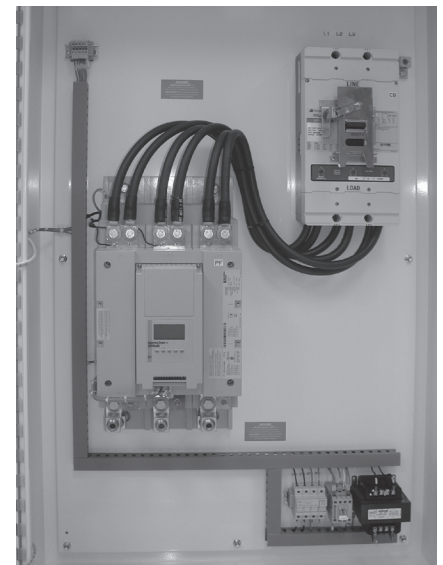

PFS Softstarter Custom MCCB Combo  
400HP@480V AC

## Need Other Types of Enclosure Ratings?

The PCS/PF Softstarters can be enclosed in a variety of enclosures away from our standard listing in this section. Whether it's an outdoor rated Type-12 with a drip shield, corrosive resistant Type-4X Non-Metallic or an ATEX Approved enclosure, our Sprecher+Schuh team has vast custom control experience in meeting your enclosure environmental specifications.

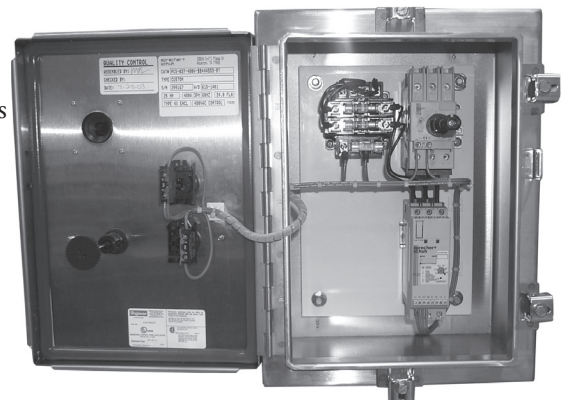

PCS Softstarter KTA7 Combo  
25HP@480V Stainless Steel

# PCS Controllers

DIN-rail mounted softstarters up to 85A. Larger softstarter frame sizes up to 480A (400HP @480V)

D  
PCS Softstarters

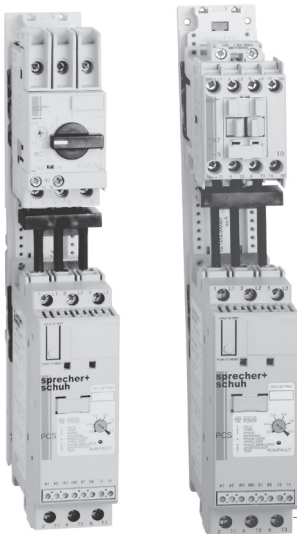

Sprecher + Schuh DIN-rail mounted Controllers can be direct connected to CA7 contactors to provide isolation or to KT7 Motor Circuit Controllers for branch circuit protection (for models up to 37A)

The PCS Softstarter Controller is Sprecher + Schuh's solid-state controller with rich features at an economical price. This softstarter is specifically designed to start 3-phase motors (up to 400HP@460V / 500HP@575V), but is very compact, easy to use and DIN-rail mountable for models up to 85A. Four standard starting modes are available with the PCS Controller:

- Soft Start
- Soft Start with Selectable Kick-Start
- Current Limit Starting
- Soft Start with Soft Stop

All PCS Softstarters are designed to control either a standard 3-phase squirrel-cage induction motor or a wye-delta motor (700HP @ 460V/900HP @ 575V Y-D).

## For use anywhere

PCS Softstarters come in three different frame sizes. The smallest frame is from 3A...37A, the middle size is from 43A...85A and the largest frame size is 108A...480A. These units are available from 200V...600V - 50/60 Hz. This assures the devices can be used anywhere in the world.

## Many convenient features

**Easy Set-up** – Digital rotary switches are quickly and easily set to the exact value. LED indication of all faults is standard.

**Built-in Overload Protection** – PCS Softstarters are equipped with electronic overload protection, accomplished with the use of current transformers on each of the three phases. Protection is programmable, providing total flexibility. Overload trip class selection includes OFF, 10, 15 or 20 seconds. In addition, either manual or automatic trip reset may be selected. Trip rating is 120% of dial setting.

**Bypass Contactor** – PCS controllers are equipped with a bypass contactor on each phase. Once the motor is up to speed, the load is removed from the SCRs, increasing their life and reducing heat.

**Over Temperature Protection** – The Softstarter monitors SCR temperature by means of internal thermistors. When the power poles maximum rated temperature is reached, the microcomputer switches off the PCS, a TEMP fault is indicated via LED, and the 97/98 fault contact closes.



**Phase Reversal Protection** – When enabled via a DIP-switch, 3-phase input power will be verified before starting. If input power phasing is detected to be incorrect, the start will be aborted and a fault indicated.

**Phase Loss / Open Load** – The PCS will not attempt to start if there is a single phase condition on the line. This protects from motor burnout during single phase starting.

**Phase Imbalance** – The unit monitors for imbalance between phase currents. To prevent motor damage, the unit will trip if the difference between the minimum phase current and the maximum phase current exceeds 65% for 3 seconds, and a fault will be indicated.

**Shorted SCR** – Prior to every start and during starting, the unit will check all SCRs for shorts and unit load connections to the motor. If there is a shorted SCR in the PCS and/or open load, the start will be aborted and a shorted SCR or open load fault will be indicated. This prevents damage from phase imbalance.

**Push to Test** – The unit with control wiring can be tested for fault conditions by using the Push to Test function. Hold down the Reset button for 7 seconds to activate the fault Aux (97, 98) and shut down the PCS. To clear, either push the Reset button or cycle control power to the device.

### LED Description (Number of Flashes)

1. Overload
2. Overtemperature
3. Phase Reversal
4. Phase Loss/Open Load
5. Phase Imbalance
6. Shorted SCR
7. Test

**Modes of Operation (Standard)**

Soft Start	
	<p>This method has the most general application. The motor is raised from an initial torque value to full voltage. Initial torque is adjustable to 15%, 25%, 35% or 65% locked rotor torque. The motor voltage is gradually increased during the acceleration ramp time, which can be adjusted from 2, 5, 10, 15, 20, 25 or 30 seconds.</p>
Soft Start with Selectable Kickstart	
	<p>During the Soft Start phase, an initial kickstart or boost can be provided. This supplies a current pulse of 450% of full load current and is adjustable from 0.5 to 1.5 seconds. This allows the motor to develop additional torque for starting high inertia loads.</p>
Current Limit Starting	
	<p>This starting mode is used when it is desired to limit the maximum starting current (inrush). It can be adjusted for 150%, 250%, 350% or 450% of full load amps. Start times are selectable from 2, 5, 10, 15, 20, 25 or 30 seconds. If the motor is not up to speed after the selected time elapses, the controller transitions to full voltage.</p>
Soft Stop	
	<p>Soft Stop can be used for applications requiring an extended coast-to-rest, such as frictional type loads that tend to stop suddenly when voltage is removed from the motor. When enabled, the voltage ramp down time is equal to one, two or three times the start time selected. The load stops when the motor voltage drops to a point where the load torque is greater than the motor torque.</p>

**D**  
PCS Softstarters

### Open Type - Line Connected Controllers ②③⑤

Rated Voltage (V AC)	Current Rating (Amps) ①	Starting Duty		With 100...240V AC Control Voltage	With 24V AC/DC Control Voltage
		kW 50 Hz	Hp 60Hz	Catalog Number	Catalog Number
200/208	1...3	~	0.5	PCS-003-600V	PCS-003-600V-024
	3...9	~	0.75...2	PCS-009-600V	PCS-009-600V-024
	5.3...16	~	1.5...3	PCS-016-600V	PCS-016-600V-024
	6.3...19	~	1.5...3	PCS-019-600V	PCS-019-600V-024
	9.2...25	~	3...7.5	PCS-025-600V	PCS-025-600V-024
	10...30	~	3...7.5	PCS-030-600V	PCS-030-600V-024
	12.3...37	~	5...10	PCS-037-600V	PCS-037-600V-024
	14.3...43	~	5...10	PCS-043-600V	PCS-043-600V-024
	20...60	~	7.5...15	PCS-060-600V	PCS-060-600V-024
	28.3...85	~	10...25	PCS-085-600V	PCS-085-600V-024
	27...108	~	20...30	PCS-108-600V ④	PCS-108-600V-024 ④
	34...135	~	25...40	PCS-135-600V ④	PCS-135-600V-024 ④
	67...201	~	40...60	PCS-201-600V ④	PCS-201-600V-024 ④
	84...251	~	50...75	PCS-251-600V ④	PCS-251-600V-024 ④
	106...317	~	60...100	PCS-317-600V ④	PCS-317-600V-024 ④
	120...361	~	75...125	PCS-361-600V ④	PCS-361-600V-024 ④
160...480	~	100...150	PCS-480-600V ④	PCS-480-600V-024 ④	
230	1...3	0.55	0.5	PCS-003-600V	PCS-003-600V-024
	3...9	2.2	0.75...2	PCS-009-600V	PCS-009-600V-024
	5.3...16	4	1.5...5	PCS-016-600V	PCS-016-600V-024
	6.3...19	4	2...5	PCS-019-600V	PCS-019-600V-024
	9.2...25	5.5	3...7.5	PCS-025-600V	PCS-025-600V-024
	10...30	7.5	5...10	PCS-030-600V	PCS-030-600V-024
	12.3...37	7.5	5...10	PCS-037-600V	PCS-037-600V-024
	14.3...43	11	5...15	PCS-043-600V	PCS-043-600V-024
	20...60	15	7.5...20	PCS-060-600V	PCS-060-600V-024
	28.3...85	22	15...30	PCS-085-600V	PCS-085-600V-024
	27...108	30	20...40	PCS-108-600V ④	PCS-108-600V-024 ④
	34...135	37	25...50	PCS-135-600V ④	PCS-135-600V-024 ④
	67...201	55	40...75	PCS-201-600V ④	PCS-201-600V-024 ④
	84...251	75	50...100	PCS-251-600V ④	PCS-251-600V-024 ④
	106...317	90	60...125	PCS-317-600V ④	PCS-317-600V-024 ④
	120...361	110	75...150	PCS-361-600V ④	PCS-361-600V-024 ④
160...480	132	100...200	PCS-480-600V ④	PCS-480-600V-024 ④	

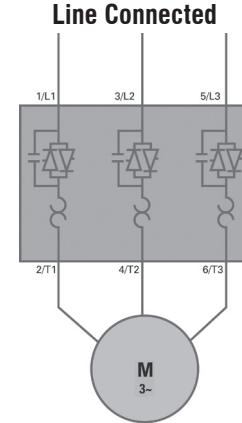

PCS Softstarters

- ① Motor FLA rating must fall within the specified current range for unit to operate properly. Special consideration should be given when using a motor with a potentially high starting current (greater than ten times motor FLA) with the PCS in the "Full Voltage" starting mode. The overload setting must be set to the motor FLA regardless if the Overload Function is "OFF" (disabled). Contact Sprecher+Schuh technical support for further guidance.
- ② See page D25 for maximum starts per hour.

- ③ Prior to the initial start of the motor at the final installation location:
  - The bypass relays on the main circuit may be in an undefined switching state due to handling during shipping. Before connecting the main power source, apply the control voltage to set the bypass relays to a defined switching state. If this step is not performed, inadvertent operation of the motor may occur.
- ④ Separate 120V or 240V single phase is required for PCS fan operation.
- ⑤ Controllers rated 108A and greater are not equipped with the line and load terminal lugs. See page D20 for terminal lug kits.



**Open Type - Line Connected Controllers cont. ②③⑤**

Rated Voltage (V AC)	Current Rating (Amps) ①	Starting Duty		With 100...240V AC Control Voltage	
		kW 50 Hz	Hp 60Hz	Catalog Number	Catalog Number
380/400/ 415/460	1...3	1.1	0.5...1.5	PCS-003-600V	PCS-003-600V-024
	3...9	4	1.5...5	PCS-009-600V	PCS-009-600V-024
	5.3...16	7.5	5...10	PCS-016-600V	PCS-016-600V-024
	6.3...19	7.5	5...10	PCS-019-600V	PCS-019-600V-024
	9.2...25	11	7.5...15	PCS-025-600V	PCS-025-600V-024
	10...30	15	7.5...20	PCS-030-600V	PCS-030-600V-024
	12.3...37	18.5	10...25	PCS-037-600V	PCS-037-600V-024
	14.3...43	22	10...30	PCS-043-600V	PCS-043-600V-024
	20...60	30	15...40	PCS-060-600V	PCS-060-600V-024
	28.3...85	45	25...60	PCS-085-600V	PCS-085-600V-024
	27...108	55	50...75	PCS-108-600V ④	PCS-108-600V-024 ④
	34...135	75	60...100	PCS-135-600V ④	PCS-135-600V-024 ④
	67...201	95...110	75...150	PCS-201-600V ④	PCS-201-600V-024 ④
	84...251	95...132	100...200	PCS-251-600V ④	PCS-251-600V-024 ④
	106...317	95...160	125...250	PCS-317-600V ④	PCS-317-600V-024 ④
	120...361	110...200	250...300	PCS-361-600V ④	PCS-361-600V-024 ④
160...480	160...250	300...400	PCS-480-600V ④	PCS-480-600V-024 ④	
500/575	1...3	1.5	0.75...2	PCS-003-600V	PCS-003-600V-024
	3...9	5.5	3...7.5	PCS-009-600V	PCS-009-600V-024
	5.3...16	7.5	5...10	PCS-016-600V	PCS-016-600V-024
	6.3...19	11	7.5...15	PCS-019-600V	PCS-019-600V-024
	9.2...25	15	7.5...20	PCS-025-600V	PCS-025-600V-024
	10...30	18.5	10...25	PCS-030-600V	PCS-030-600V-024
	12.3...37	22	15...30	PCS-037-600V	PCS-037-600V-024
	14.3...43	22	15...40	PCS-043-600V	PCS-043-600V-024
	20...60	37	20...50	PCS-060-600V	PCS-060-600V-024
	28.3...85	55	30...75	PCS-085-600V	PCS-085-600V-024
	27...108	75	60...100	PCS-108-600V ④	PCS-108-600V-024 ④
	34...135	90	75...125	PCS-135-600V ④	PCS-135-600V-024 ④
	67...201	75...132	100...200	PCS-201-600V ④	PCS-201-600V-024 ④
	84...251	90...160	125...250	PCS-251-600V ④	PCS-251-600V-024 ④
	106...317	100...200	200...300	PCS-317-600V ④	PCS-317-600V-024 ④
	120...361	132...250	200...350	PCS-361-600V ④	PCS-361-600V-024 ④
160...480	200...315	250...500	PCS-480-600V ④	PCS-480-600V-024 ④	

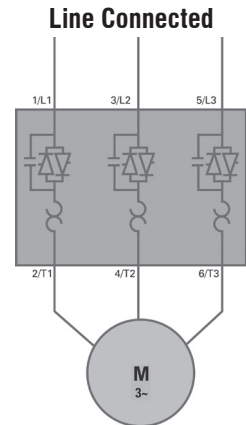

**D**  
PCS Softstarters

- ① Motor FLA rating must fall within the specified current range for unit to operate properly. Special consideration should be given when using a motor with a potentially high starting current (greater than ten times motor FLA) with the PCS in the "Full Voltage" starting mode. The overload setting must be set to the motor FLA regardless if the Overload Function is "OFF" (disabled). Contact Sprecher+Schuh technical support for further guidance.
- ② See page D25 for maximum starts per hour.

- ③ Prior to the initial start of the motor at the final installation location:
  - The bypass relays on the main circuit may be in an undefined switching state due to handling during shipping. Before connecting the main power source, apply the control voltage to set the bypass relays to a defined switching state. If this step is not performed, inadvertent operation of the motor may occur.
- ④ Separate 120V or 240V single phase is required for PCS fan operation.
- ⑤ Controllers rated 108A and greater are not equipped with the line and load terminal lugs. See page D20 for terminal lug kits.

### Open Type - Delta Connected Controllers ②④⑤

Rated Voltage (V AC)	Current Rating (Amps) ①	Starting Duty		With 100...240V AC Control Voltage	With 24V AC/DC Control Voltage
		kW 50 Hz	Hp 60Hz	Catalog Number	Catalog Number
200/208	1.7...5.1	~	1	PCS-003-600V	PCS-003-600V-024
	5.1...16	~	1.5...3	PCS-009-600V	PCS-009-600V-024
	9.1...27.6	~	3...7.5	PCS-016-600V	PCS-016-600V-024
	10.9...32.8	~	3...10	PCS-019-600V	PCS-019-600V-024
	14.3...43	~	3...10	PCS-025-600V	PCS-025-600V-024
	17.3...52	~	5...10	PCS-030-600V	PCS-030-600V-024
	21...64	~	7.5...20	PCS-037-600V	PCS-037-600V-024
	25...74	~	7.5...20	PCS-043-600V	PCS-043-600V-024
	34.6...104	~	15...30	PCS-060-600V	PCS-060-600V-024
	50...147	~	15...40	PCS-085-600V	PCS-085-600V-024
	47...187	~	20...60	PCS-108-600V ③	PCS-108-600V-024 ③
	59...234	~	20...75	PCS-135-600V ③	PCS-135-600V-024 ③
	116...348	~	75...100	PCS-201-600V ③	PCS-201-600V-024 ③
	145...435	~	100...150	PCS-251-600V ③	PCS-251-600V-024 ③
	183...549	~	100...200	PCS-317-600V ③	PCS-317-600V-024 ③
	208...625	~	125...200	PCS-361-600V ③	PCS-361-600V-024 ③
	277...831	~	200...300	PCS-480-600V ③	PCS-480-600V-024 ③
230	1.7...5.1	0.25...1.1	1	PCS-003-600V	PCS-003-600V-024
	5.1...16	1.1...4	1...5	PCS-009-600V	PCS-009-600V-024
	9.1...27.6	2.2...7.5	3...7.5	PCS-016-600V	PCS-016-600V-024
	10.9...32.8	2.2...7.5	3...10	PCS-019-600V	PCS-019-600V-024
	14.3...43	4...11	3...15	PCS-025-600V	PCS-025-600V-024
	17.3...52	4...15	5...15	PCS-030-600V	PCS-030-600V-024
	21...64	5.5...18.5	7.5...20	PCS-037-600V	PCS-037-600V-024
	25...74	5.5...22	7.5...25	PCS-043-600V	PCS-043-600V-024
	34.6...104	7.5...30	15...40	PCS-060-600V	PCS-060-600V-024
	50...147	15...45	20...50	PCS-085-600V	PCS-085-600V-024
	47...187	55	20...60	PCS-108-600V ③	PCS-108-600V-024 ③
	59...234	75	25...75	PCS-135-600V ③	PCS-135-600V-024 ③
	116...348	110	75...125	PCS-201-600V ③	PCS-201-600V-024 ③
	145...435	132	100...150	PCS-251-600V ③	PCS-251-600V-024 ③
	183...549	160	125...200	PCS-317-600V ③	PCS-317-600V-024 ③
	208...625	200	150...250	PCS-361-600V ③	PCS-361-600V-024 ③
	277...831	250	200...300	PCS-480-600V ③	PCS-480-600V-024 ③

Delta Connected

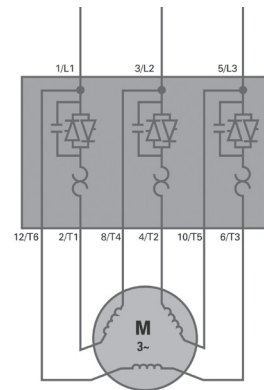

[All PCS Models are] Wye-Delta compatible

PCS Softstarters

① Motor FLA rating must fall within the specified current range for unit to operate properly. Special consideration should be given when using a motor with a potentially high starting current (greater than ten times motor FLA) with the PCS in the "Full Voltage" starting mode. The overload setting must be set to the motor FLA regardless if the Overload Function is "OFF" (disabled). Contact Sprecher+Schuh technical support for further guidance.

② Prior to the initial start of the motor at the final installation location:  
 - The bypass relays on the main circuit may be in an undefined switching state due to handling during shipping. Before connecting the main power source, apply the control voltage to set the bypass relays to a defined switching state. If this step is not performed, inadvertent operation of the motor may occur.

③ Separate 120V or 240V single phase is required for PCS fan operation.

④ Controllers rated 108A and greater are not equipped with the line and load terminal lugs. See page D20 for terminal lug kits.

⑤ It is recommended that an isolation contactor be added to the circuit to provide galvanic isolation of the motor and final electromechanical removal of power.

**Open Type - Delta Connected Controllers cont. ②④⑤**

Rated Voltage (V AC)	Current Rating (Amps) ①	Starting Duty		With 100...240V AC Control Voltage	With 24V AC/DC Control Voltage
		kW 50 Hz	Hp 60Hz	Catalog Number	Catalog Number
380/400/415/460	1.7...5.1	0.55...2.2	0.5...2	PCS-003-600V	PCS-003-600V-024
	5.1...16	2.2...7.5	2...7.5	PCS-009-600V	PCS-009-600V-024
	9.1...27.6	4...11	5...15	PCS-016-600V	PCS-016-600V-024
	10.9...32.8	4...15	5...15	PCS-019-600V	PCS-019-600V-024
	14.3...43	5.5...22	7.5...20	PCS-025-600V	PCS-025-600V-024
	17.3...52	7.5...22	7.5...30	PCS-030-600V	PCS-030-600V-024
	21...64	7.5...30	10...40	PCS-037-600V	PCS-037-600V-024
	25...74	11...37	10...50	PCS-043-600V	PCS-043-600V-024
	34.6...104	15...55	20...75	PCS-060-600V	PCS-060-600V-024
	50...147	22...75	25...100	PCS-085-600V	PCS-085-600V-024
	47...187	90	40...150	PCS-108-600V ⑥	PCS-108-600V-024 ⑥
	59...234	132	50...150	PCS-135-600V ⑥	PCS-135-600V-024 ⑥
	116...348	160	150...250	PCS-201-600V ⑥	PCS-201-600V-024 ⑥
	145...435	250	200...350	PCS-251-600V ⑥	PCS-251-600V-024 ⑥
	183...549	315	250...450	PCS-317-600V ⑥	PCS-317-600V-024 ⑥
	208...625	355	300...500	PCS-361-600V ⑥	PCS-361-600V-024 ⑥
	277...831	450	350...700	PCS-480-600V ⑥	PCS-480-600V-024 ⑥
500/575	1.7...5.1	0.75...3	1...3	PCS-003-600V	PCS-003-600V-024
	5.1...16	3...7.5	3...10	PCS-009-600V	PCS-009-600V-024
	9.1...27.6	5.5...15	7.5...20	PCS-016-600V	PCS-016-600V-024
	10.9...32.8	5.5...22	7.5...30	PCS-019-600V	PCS-019-600V-024
	14.3...43	7.5...22	10...40	PCS-025-600V	PCS-025-600V-024
	17.3...52	11...30	15...50	PCS-030-600V	PCS-030-600V-024
	21...64	11...37	15...60	PCS-037-600V	PCS-037-600V-024
	25...74	15...45	20...60	PCS-043-600V	PCS-043-600V-024
	84.6...104	22...55	30...100	PCS-060-600V	PCS-060-600V-024
	50...147	30...90	40...150	PCS-085-600V	PCS-085-600V-024
	47...187	132	50...150	PCS-108-600V ⑥	PCS-108-600V-024 ⑥
	59...234	160	60...200	PCS-135-600V ⑥	PCS-135-600V-024 ⑥
	116...348	250	250...300	PCS-201-600V ⑥	PCS-201-600V-024 ⑥
	145...435	315	250...400	PCS-251-600V ⑥	PCS-251-600V-024 ⑥
	183...549	400	300...500	PCS-317-600V ⑥	PCS-317-600V-024 ⑥
	208...625	450	350...600	PCS-361-600V ⑥	PCS-361-600V-024 ⑥
	277...831	560	400...900	PCS-480-600V ⑥	PCS-480-600V-024 ⑥

**Delta Connected**

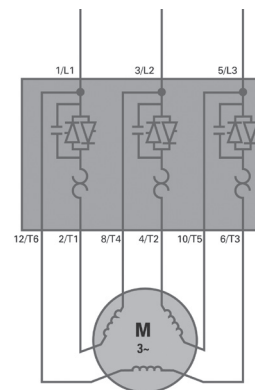

[All PCS Models are Wye-Delta compatible]

**D**  
PCS Softstarters

- ① Motor FLA rating must fall within the specified current range for unit to operate properly. Special consideration should be given when using a motor with a potentially high starting current (greater than ten times motor FLA) with the PCS in the "Full Voltage" starting mode. The overload setting must be set to the motor FLA regardless if the Overload Function is "OFF" (disabled). Contact Sprecher+Schuh technical support for further guidance.
- ② Prior to the initial start of the motor at the final installation location:
  - The bypass relays on the main circuit may be in an undefined switching state due to handling during shipping. Before connecting the main power source, apply the control voltage to set the bypass relays to a defined switching state. If this step is not performed, inadvertent operation of the motor may occur.

- ③ Separate 120V or 240V single phase is required for PCS fan operation.
- ④ Controllers rated 108A and greater are not equipped with the line and load terminal lugs. See page D20 for terminal lug kits.
- ⑤ It is recommended that an isolation contactor be added to the circuit to provide galvanic isolation of the motor and final electromechanical removal of power.

### Enclosed Non-Combination Starters - Line Connected ①②④⑥

Rated Voltage (V AC)	Current Rating (Amps) ⑤	Starting Duty		Type 12 [Type 3R ⑥] Industrial Dusttight Catalog Number	Type 4 Watertight Catalog Number
		kW 50 Hz	Hp 60Hz		
200/208	1...3	~	0.5	PCS-003-NHDD	PCS-003-NHDW
	3...9	~	0.75...2	PCS-009-NHDD	PCS-009-NHDW
	5.3...16	~	1.5...3	PCS-016-NHDD	PCS-016-NHDW
	6.3...19	~	1.5...3	PCS-019-NHDD	PCS-019-NHDW
	9.2...25	~	3...7.5	PCS-025-NHDD	PCS-025-NHDW
	10...30	~	3...7.5	PCS-030-NHDD	PCS-030-NHDW
	12.3...37	~	5...10	PCS-037-NHDD	PCS-037-NHDW
	14.3...43	~	5...10	PCS-043-NHDD	PCS-043-NHDW
	20...60	~	7.5...15	PCS-060-NHDD	PCS-060-NHDW
	28.3...85	~	10...25	PCS-085-NHDD	PCS-085-NHDW
	27...108	~	20...30	PCS-108-NHDD	PCS-108-NHDW
	34...135	~	25...40	PCS-135-NHDD	PCS-135-NHDW
	67...201	~	40...60	PCS-201-NHDD	PCS-201-NHDW
	84...251	~	50...75	PCS-251-NHDD	PCS-251-NHDW
	106...317	~	60...100	PCS-317-NHDD	PCS-317-NHDW
	120...361	~	75...125	PCS-361-NHDD	PCS-361-NHDW
160...480	~	100...150	PCS-480-NHDD	PCS-480-NHDW	
230	1...3	0.55	0.5	PCS-003-NADD	PCS-003-NADW
	3...9	2.2	0.75...2	PCS-009-NADD	PCS-009-NADW
	5.3...16	4	1.5...5	PCS-016-NADD	PCS-016-NADW
	6.3...19	4	2...5	PCS-019-NADD	PCS-019-NADW
	9.2...25	5.5	3...7.5	PCS-025-NADD	PCS-025-NADW
	10...30	7.5	5...10	PCS-030-NADD	PCS-030-NADW
	12.3...37	7.5	5...10	PCS-037-NADD	PCS-037-NADW
	14.3...43	11	5...15	PCS-043-NADD	PCS-043-NADW
	20...60	15	7.5...20	PCS-060-NADD	PCS-060-NADW
	28.3...85	22	15...30	PCS-085-NADD	PCS-085-NADW
	27...108	30	20...40	PCS-108-NADD	PCS-108-NADW
	34...135	37	25...50	PCS-135-NADD	PCS-135-NADW
	67...201	55	40...75	PCS-201-NADD	PCS-201-NADW
	84...251	75	50...100	PCS-251-NADD	PCS-251-NADW
	106...317	90	60...125	PCS-317-NADD	PCS-317-NADW
	120...361	110	75...150	PCS-361-NADD	PCS-361-NADW
160...480	132	100...200	PCS-480-NADD	PCS-480-NADW	

### Non-Combination PCS Softstarters include:

- A 120V control power transformer with fused primary and secondary
- PCS built-in electronic motor overload protection
- PCS built-in SCR bypass/run contactor
- Available in UL Type 12 or 4 Enclosures
- Terminal blocks for remote control devices

D  
PCS Softstarters

- ① Other UL type enclosures available. Contact your Sprecher + Schuh representative for pricing.
- ② See page D18 if ordering factory installed modifications.
- ③ The nominal current rating for the combination package may differ from the controller, based on the horsepower. Consult your Sprecher + Schuh representative.
- ④ Line and load termination are provided as standard.
- ⑤ For outdoor applications, replace "D" in catalog number with an "R". All enclosures are Type-12 with a Drip Shield. Example: PCS-085-NHDD becomes PCS-085-NHDR.

- ⑥ Motor FLA rating must fall within the specified current range for unit to operate properly. Special consideration should be given when using a motor with a potentially high starting current (greater than ten times motor FLA) with the PCS in the "Full Voltage" starting mode. The overload setting must be set to the motor FLA regardless if the Overload Function is "OFF" (disabled). Contact Sprecher+Schuh technical support for further guidance.



**Enclosed Non-Combination Starters - Line Connected ①②④⑦**

Rated Voltage (V AC)	Current Rating (Amps) ⑤	Starting Duty		Type 12 [Type 3R ⑥] Industrial Dusttight Catalog Number	Type 4 Watertight Catalog Number
		kW 50 Hz	Hp 60Hz		
460 ⑤	1...3	1.1	0.5...1.5	PCS-003-NBDD	PCS-003-NBDW
	3...9	4	1.5...5	PCS-009-NBDD	PCS-009-NBDW
	5.3...16	7.5	5...10	PCS-016-NBDD	PCS-016-NBDW
	6.3...19	7.5	5...10	PCS-019-NBDD	PCS-019-NBDW
	9.2...25	11	7.5...15	PCS-025-NBDD	PCS-025-NBDW
	10...30	15	7.5...20	PCS-030-NBDD	PCS-030-NBDW
	12.3...37	18.5	10...25	PCS-037-NBDD	PCS-037-NBDW
	14.3...43	22	10...30	PCS-043-NBDD	PCS-043-NBDW
	20...60	30	15...40	PCS-060-NBDD	PCS-060-NBDW
	28.3...85	45	25...60	PCS-085-NBDD	PCS-085-NBDW
	27...108	55	50...75	PCS-108-NBDD	PCS-108-NBDW
	34...135	75	60...100	PCS-135-NBDD	PCS-135-NBDW
	67...201	95...110	75...150	PCS-201-NBDD	PCS-201-NBDW
	84...251	95...132	100...200	PCS-251-NBDD	PCS-251-NBDW
	106...317	95...160	125...250	PCS-317-NBDD	PCS-317-NBDW
120...361	110...200	250...300	PCS-361-NBDD	PCS-361-NBDW	
160...480	160...250	300...400	PCS-480-NBDD	PCS-480-NBDW	
500/575	1...3	1.5	0.75...2	PCS-003-NCDD	PCS-003-NCDW
	3...9	5.5	3...7.5	PCS-009-NCDD	PCS-009-NCDW
	5.3...16	7.5	5...10	PCS-016-NCDD	PCS-016-NCDW
	6.3...19	11	7.5...15	PCS-019-NCDD	PCS-019-NCDW
	9.2...25	15	7.5...20	PCS-025-NCDD	PCS-025-NCDW
	10...30	18.5	10...25	PCS-030-NCDD	PCS-030-NCDW
	12.3...37	22	15...30	PCS-037-NCDD	PCS-037-NCDW
	14.3...43	22	15...40	PCS-043-NCDD	PCS-043-NCDW
	20...60	37	20...50	PCS-060-NCDD	PCS-060-NCDW
	28.3...85	55	30...75	PCS-085-NCDD	PCS-085-NCDW
	27...108	75	60...100	PCS-108-NCDD	PCS-108-NCDW
	34...135	90	75...125	PCS-135-NCDD	PCS-135-NCDW
	67...201	75...132	100...200	PCS-201-NCDD	PCS-201-NCDW
	84...251	90...160	125...250	PCS-251-NCDD	PCS-251-NCDW
	106...317	100...200	200...300	PCS-317-NCDD	PCS-317-NCDW
120...361	132...250	200...350	PCS-361-NCDD	PCS-361-NCDW	
160...480	200...315	250...500	PCS-480-NCDD	PCS-480-NCDW	

**Non-Combination PCS Softstarters include:**

- A 120V control power transformer with fused primary and secondary
- PCS built-in electronic motor overload protection
- PCS built-in SCR bypass/run contactor
- Available in UL Type 12 or 4 Enclosures
- Terminal blocks for remote control devices

**D**  
 PCS Softstarters

① Other UL type enclosures available. Contact your Sprecher + Schuh representative for pricing.

② See page D18 if ordering factory installed modifications.

③ The nominal current rating for the combination package may differ from the controller, based on the horsepower. Consult your Sprecher + Schuh representative.

④ Line and load termination are provided as standard.

⑤ For 380V applications choose softstarter based on FLA, then change the NB code in the catalog number to NG. For example PCS-043-NBDD becomes PCS-043-NGDD, which covers 25 HP @ 380V FLA 37.

⑥ For outdoor applications, replace "D" in catalog number with an "R". All enclosures are Type-12 with a Drip Shield. Example: PCS-085-NBDD becomes PCS-085-NBDR.

⑦ Motor FLA rating must fall within the specified current range for unit to operate properly. Special consideration should be given when using a motor with a potentially high starting current (greater than ten times motor FLA) with the PCS in the "Full Voltage" starting mode. The overload setting must be set to the motor FLA regardless if the Overload Function is "OFF" (disabled). Contact Sprecher+Schuh technical support for further guidance.

### Enclosed Combination Circuit Breaker Starters - Line Connected ①②④⑥

Rated Voltage (V AC)	Current Rating (Amps) ③	Starting Duty		Type 12 [Type 3R ⑤] Industrial Dusttight Catalog Number	Type 4 Watertight Catalog Number
		kW 50 Hz	Hp 60Hz		
200	3	—	0.5	PCS-003-BHD33D	PCS-003-BHD33W
	9	—	0.75	PCS-009-BHD34D	PCS-009-BHD34W
	9	—	1	PCS-009-BHD35D	PCS-009-BHD35W
	9	—	1.5	PCS-009-BHD36D	PCS-009-BHD36W
	16	—	2	PCS-016-BHD37D	PCS-016-BHD37W
	16	—	3	PCS-016-BHD38D	PCS-016-BHD38W
	25	—	5	PCS-025-BHD39D	PCS-025-BHD39W
	37	—	7.5	PCS-037-BHD40D	PCS-037-BHD40W
	43	—	10	PCS-043-BHD41D	PCS-043-BHD41W
	60	—	15	PCS-060-BHD42D	PCS-060-BHD42W
	85	—	20	PCS-085-BHD43D	PCS-085-BHD43W
	85	—	25	PCS-085-BHD44D	PCS-085-BHD44W
	108	—	30	PCS-108-BHD45D	PCS-108-BHD45W
	135	—	40	PCS-135-BHD46D	PCS-135-BHD46W
	201	—	60	PCS-201-BHD48D	PCS-201-BHD48W
	251	—	75	PCS-251-BHD49D	PCS-251-BHD49W
317	—	100	PCS-317-BHD50D	PCS-317-BHD50W	
361	—	125	PCS-361-BHD51D	PCS-361-BHD51W	
480	—	150	PCS-480-BHD52D	PCS-480-BHD52W	
230	3	0.37	0.5	PCS-003-BAD33D	PCS-003-BAD33W
	9	0.55	0.75	PCS-009-BAD34D	PCS-009-BAD34W
	9	0.75	1	PCS-009-BAD35D	PCS-009-BAD35W
	9	1.1	1.5	PCS-009-BAD36D	PCS-009-BAD36W
	9	1.5	2	PCS-009-BAD37D	PCS-009-BAD37W
	16	2.2	3	PCS-016-BAD38D	PCS-016-BAD38W
	25	3.7	5	PCS-025-BAD39D	PCS-025-BAD39W
	30	5.5	7.5	PCS-030-BAD40D	PCS-030-BAD40W
	37	7.5	10	PCS-037-BAD41D	PCS-037-BAD41W
	43	11	15	PCS-043-BAD42D	PCS-043-BAD42W
	60	15	20	PCS-060-BAD43D	PCS-060-BAD43W
	85	18.5	25	PCS-085-BAD44D	PCS-085-BAD44W
	85	22	30	PCS-085-BAD45D	PCS-085-BAD45W
	108	30	40	PCS-108-BAD46D	PCS-108-BAD46W
	135	37	50	PCS-135-BAD47D	PCS-135-BAD47W
	201	55	75	PCS-201-BAD49D	PCS-201-BAD49W
251	75	100	PCS-251-BAD50D	PCS-251-BAD50W	
317	90	125	PCS-317-BAD51D	PCS-317-BAD51W	
361	110	150	PCS-361-BAD52D	PCS-361-BAD52W	
480	147	200	PCS-480-BAD54D	PCS-480-BAD54W	

### Combination Circuit Breaker PCS Softstarters include:

- A thermal magnetic circuit breaker with external operating handle
- A 120V control power transformer with fused primary and secondary
- PCS built-in electronic motor overload protection
- PCS built-in SCR bypass/run contactor
- Available in UL Type 12 or 4 Enclosures
- Terminal blocks for remote control devices

D PCS Softstarters

- ① Other UL type enclosures available. Contact your Sprecher + Schuh representative for pricing.
- ② See page D18 if ordering factory installed modifications.
- ③ The nominal current rating for the combination package may differ from the controller, based on the horsepower. Consult your Sprecher + Schuh representative.
- ④ See page D29 for circuit breaker ratings.
- ⑤ For outdoor applications, replace "D" in catalog number with an "R". All enclosures are Type-12 with a Drip Shield. Example: PCS-085-BHD43D becomes PCS-085-BHD43R.

- ⑥ Motor FLA rating must fall within the specified current range for unit to operate properly. Special consideration should be given when using a motor with a potentially high starting current (greater than ten times motor FLA) with the PCS in the "Full Voltage" starting mode. The overload setting must be set to the motor FLA regardless if the Overload Function is "OFF" (disabled). Contact Sprecher+Schuh technical support for further guidance.

**Enclosed Combination Circuit Breaker Starters - Line Connected ①②④⑦**

Rated Voltage (V AC)	Current Rating (Amps) ③	Starting Duty		Type 12 [Type 3R ④] Industrial Dustight Catalog Number	Type 4 Watertight Catalog Number
		kW 50 Hz	Hp 60Hz		
460 ⑤	3	0.37	0.5	PCS-003-BBD33D	PCS-003-BBD33W
	3	0.55	0.75	PCS-003-BBD34D	PCS-003-BBD34W
	3	0.75	1	PCS-003-BBD35D	PCS-003-BBD35W
	9	1.1	1.5	PCS-009-BBD36D	PCS-009-BBD36W
	9	1.5	2	PCS-009-BBD37D	PCS-009-BBD37W
	9	2.2	3	PCS-009-BBD38D	PCS-009-BBD38W
	16	3.7	5	PCS-016-BBD39D	PCS-016-BBD39W
	16	5.5	7.5	PCS-016-BBD40D	PCS-016-BBD40W
	25	7.5	10	PCS-025-BBD41D	PCS-025-BBD41W
	30	11	15	PCS-030-BBD42D	PCS-030-BBD42W
	37	15	20	PCS-037-BBD43D	PCS-037-BBD43W
	43	18.5	25	PCS-043-BBD44D	PCS-043-BBD44W
	43	22	30	PCS-043-BBD45D	PCS-043-BBD45W
	60	30	40	PCS-060-BBD46D	PCS-060-BBD46W
	85	37	50	PCS-085-BBD47D	PCS-085-BBD47W
	85	45	60	PCS-085-BBD48D	PCS-085-BBD48W
	108	55	75	PCS-108-BBD49D	PCS-108-BBD49W
	135	75	100	PCS-135-BBD50D	PCS-135-BBD50W
201	110	150	PCS-201-BBD52D	PCS-201-BBD52W	
251	132	200	PCS-251-BBD54D	PCS-251-BBD54W	
317	160	250	PCS-317-BBD56D	PCS-317-BBD56W	
361	200	300	PCS-361-BBD57D	PCS-361-BBD57W	
480	250	400	PCS-480-BBD59D	PCS-480-BBD59W	
575	3	0.55	0.75	PCS-003-BCD34D	PCS-003-BCD34W
	3	0.75	1	PCS-003-BCD35D	PCS-003-BCD35W
	9	1.1	1.5	PCS-009-BCD36D	PCS-009-BCD36W
	9	1.5	2	PCS-009-BCD37D	PCS-009-BCD37W
	9	2.2	3	PCS-009-BCD38D	PCS-009-BCD38W
	9	3.7	5	PCS-009-BCD39D	PCS-009-BCD39W
	16	5.5	7.5	PCS-016-BCD40D	PCS-016-BCD40W
	16	7.5	10	PCS-016-BCD41D	PCS-016-BCD41W
	25	11	15	PCS-025-BCD42D	PCS-025-BCD42W
	30	15	20	PCS-030-BCD43D	PCS-030-BCD43W
	37	18.5	25	PCS-037-BCD44D	PCS-037-BCD44W
	43	22	30	PCS-043-BCD45D	PCS-043-BCD45W
	43	30	40	PCS-043-BCD46D	PCS-043-BCD46W
	60	37	50	PCS-060-BCD47D	PCS-060-BCD47W
	85	45	60	PCS-085-BCD48D	PCS-085-BCD48W
	85	55	75	PCS-085-BCD49D	PCS-085-BCD49W
	108	75	100	PCS-108-BCD50D	PCS-108-BCD50W
	135	90	125	PCS-135-BCD51D	PCS-135-BCD51W
201	132	200	PCS-201-BCD54D	PCS-201-BCD54W	
251	160	250	PCS-251-BCD56D	PCS-251-BCD56W	
317	200	300	PCS-317-BCD57D	PCS-317-BCD57W	
361	250	350	PCS-361-BCD58D	PCS-361-BCD58W	
480	315	500	PCS-480-BCD61D	PCS-480-BCD61W	

**Combination Circuit Breaker**
**PCS Softstarters include:**

- A thermal magnetic circuit breaker with external operating handle
- A 120V control power transformer with fused primary and secondary
- PCS built-in electronic motor overload protection
- PCS built-in SCR bypass/run contactor
- Available in UL Type 12 or 4 Enclosures
- Terminal blocks for remote control devices

**D**  
**PCS Softstarters**

- ① Other UL type enclosures available. Contact your Sprecher + Schuh representative for pricing.
- ② See from page D18 if ordering factory installed modifications.
- ③ The nominal current rating for the combination package may differ from the controller, based on the horsepower. Consult your Sprecher + Schuh representative.
- ④ See page D29 for circuit breaker ratings.
- ⑤ For 380V applications choose softstarter based on FLA, then change the BB code in the catalog number to BG. Example PCS-043-BBD44D becomes PCS-043-BGD44D, which covers 25 HP @ 380V FLA 37.

- ⑥ For outdoor applications, replace "D" in catalog number with an "R". All enclosures are Type-12 with a Drip Shield. For example number PCS-085-BBD47D becomes PCS-085-BBD47R.
- ⑦ Motor FLA rating must fall within the specified current range for unit to operate properly. Special consideration should be given when using a motor with a potentially high starting current (greater than ten times motor FLA) with the PCS in the "Full Voltage" starting mode. The overload setting must be set to the motor FLA regardless if the Overload Function is "OFF" (disabled). Contact Sprecher+Schuh technical support for further guidance.

**Enclosed Combination Fusible Starters - Line Connected ①②④⑥**

Rated Voltage (V AC)	Current Rating (Amps) ③	Starting Duty		Type 12 [Type 3R ⑤] Industrial Dusttight Catalog Number	Type 4 Watertight Catalog Number
		kW 50 Hz	Hp 60Hz		
200	3	—	0.5	PCS-003-FHD33D	PCS-003-FHD33W
	9	—	0.75	PCS-009-FHD34D	PCS-009-FHD34W
	9	—	1	PCS-009-FHD35D	PCS-009-FHD35W
	9	—	1.5	PCS-009-FHD36D	PCS-009-FHD36W
	16	—	2	PCS-016-FHD37D	PCS-016-FHD37W
	16	—	3	PCS-016-FHD38D	PCS-016-FHD38W
	25	—	5	PCS-025-FHD39D	PCS-025-FHD39W
	37	—	7.5	PCS-037-FHD40D	PCS-037-FHD40W
	43	—	10	PCS-043-FHD41D	PCS-043-FHD41W
	60	—	15	PCS-060-FHD42D	PCS-060-FHD42W
	85	—	20	PCS-085-FHD43D	PCS-085-FHD43W
	85	—	25	PCS-085-FHD44D	PCS-085-FHD44W
	108	—	30	PCS-108-FHD45D	PCS-108-FHD45W
	135	—	40	PCS-135-FHD46D	PCS-135-FHD46W
	201	—	60	PCS-201-FHD48D	PCS-201-FHD48W
	251	—	75	PCS-251-FHD49D	PCS-251-FHD49W
	317	—	100	PCS-317-FHD50D	PCS-317-FHD50W
361	—	125	PCS-361-FHD51D	PCS-361-FHD51W	
480	—	150	PCS-480-FHD52D	PCS-480-FHD52W	
230	3	0.37	0.5	PCS-003-FAD33D	PCS-003-FAD33W
	9	0.55	0.75	PCS-009-FAD34D	PCS-009-FAD34W
	9	0.75	1	PCS-009-FAD35D	PCS-009-FAD35W
	9	1.1	1.5	PCS-009-FAD36D	PCS-009-FAD36W
	9	1.5	2	PCS-009-FAD37D	PCS-009-FAD37W
	16	2.2	3	PCS-016-FAD38D	PCS-016-FAD38W
	25	3.7	5	PCS-025-FAD39D	PCS-025-FAD39W
	30	5.5	7.5	PCS-030-FAD40D	PCS-030-FAD40W
	37	7.5	10	PCS-037-FAD41D	PCS-037-FAD41W
	43	11	15	PCS-043-FAD42D	PCS-043-FAD42W
	60	15	20	PCS-060-FAD43D	PCS-060-FAD43W
	85	18.5	25	PCS-085-FAD44D	PCS-085-FAD44W
	85	22	30	PCS-085-FAD45D	PCS-085-FAD45W
	108	30	40	PCS-108-FAD46D	PCS-108-FAD46W
	135	37	50	PCS-135-FAD47D	PCS-135-FAD47W
	201	55	75	PCS-201-FAD49D	PCS-201-FAD49W
	251	75	100	PCS-251-FAD50D	PCS-251-FAD50W
317	90	125	PCS-317-FAD51D	PCS-317-FAD51W	
361	110	150	PCS-361-FAD52D	PCS-361-FAD52W	
480	147	200	PCS-480-FAD54D	PCS-480-FAD54W	

**Combination Fusible PCS Softstarters include:**

- A fused switch with external operating handle
- A 120V control power transformer with fused primary and secondary
- PCS built-in electronic motor overload protection
- PCS built-in SCR bypass/run contactor
- Available in UL Type 12 or 4 Enclosures
- Terminal blocks for remote control devices

**D** PCS Softstarters

- ① Other UL type enclosures available. Contact your Sprecher + Schuh representative for pricing.
- ② See page D18 if ordering factory installed modifications.
- ③ The nominal current rating for the combination package may differ from the controller, based on the horsepower. Consult your Sprecher + Schuh representative.
- ④ Fuse clip accepts J-Type fuses. Power fuses are not supplied. See page D29 for Fusible Disconnect amp ratings.

- ⑤ For outdoor applications, replace "D" in catalog number with an "R". All enclosures are Type-12 with a Drip Shield. Example: PCS-085-FHD43D becomes PCS-085-FHD43R.
- ⑥ Motor FLA rating must fall within the specified current range for unit to operate properly. Special consideration should be given when using a motor with a potentially high starting current (greater than ten times motor FLA) with the PCS in the "Full Voltage" starting mode. The overload setting must be set to the motor FLA regardless if the Overload Function is "OFF" (disabled). Contact Sprecher+Schuh technical support for further guidance.



### Enclosed Combination Fusible Starters - Line Connected ①②④⑦

Rated Voltage (V AC)	Current Rating (Amps) ⑥	Starting Duty		Type 12 [Type 3R ④] Industrial Dusttight	Type 4 Watertight
		kW 50 Hz	Hp 60Hz	Catalog Number	Catalog Number
460 ⑤	3	0.37	0.5	PCS-003-FBD33D	PCS-003-FBD33W
	3	0.55	0.75	PCS-003-FBD34D	PCS-003-FBD34W
	3	0.75	1	PCS-003-FBD35D	PCS-003-FBD35W
	9	1.1	1.5	PCS-009-FBD36D	PCS-009-FBD36W
	9	1.5	2	PCS-009-FBD37D	PCS-009-FBD37W
	9	2.2	3	PCS-009-FBD38D	PCS-009-FBD38W
	16	3.7	5	PCS-016-FBD39D	PCS-016-FBD39W
	16	5.5	7.5	PCS-016-FBD40D	PCS-016-FBD40W
	25	7.5	10	PCS-025-FBD41D	PCS-025-FBD41W
	30	11	15	PCS-030-FBD42D	PCS-030-FBD42W
	37	15	20	PCS-037-FBD43D	PCS-037-FBD43W
	43	18.5	25	PCS-043-FBD44D	PCS-043-FBD44W
	43	22	30	PCS-043-FBD45D	PCS-043-FBD45W
	60	30	40	PCS-060-FBD46D	PCS-060-FBD46W
	85	37	50	PCS-085-FBD47D	PCS-085-FBD47W
	85	45	60	PCS-085-FBD48D	PCS-085-FBD48W
	108	55	75	PCS-108-FBD49D	PCS-108-FBD49W
	135	75	100	PCS-135-FBD50D	PCS-135-FBD50W
201	110	150	PCS-201-FBD52D	PCS-201-FBD52W	
251	132	200	PCS-251-FBD54D	PCS-251-FBD54W	
317	160	250	PCS-317-FBD56D	PCS-317-FBD56W	
361	200	300	PCS-361-FBD57D	PCS-361-FBD57W	
480	250	400	PCS-480-FBD59D	PCS-480-FBD59W	
575	3	0.55	0.75	PCS-003-FCD34D	PCS-003-FCD34W
	3	0.75	1	PCS-003-FCD35D	PCS-003-FCD35W
	9	1.1	1.5	PCS-009-FCD36D	PCS-009-FCD36W
	9	1.5	2	PCS-009-FCD37D	PCS-009-FCD37W
	9	2.2	3	PCS-009-FCD38D	PCS-009-FCD38W
	9	3.7	5	PCS-009-FCD39D	PCS-009-FCD39W
	16	5.5	7.5	PCS-016-FCD40D	PCS-016-FCD40W
	16	7.5	10	PCS-016-FCD41D	PCS-016-FCD41W
	25	11	15	PCS-025-FCD42D	PCS-025-FCD42W
	30	15	20	PCS-030-FCD43D	PCS-030-FCD43W
	37	18.5	25	PCS-037-FCD44D	PCS-037-FCD44W
	43	22	30	PCS-043-FCD45D	PCS-043-FCD45W
	43	30	40	PCS-043-FCD46D	PCS-043-FCD46W
	60	37	50	PCS-060-FCD47D	PCS-060-FCD47W
	85	45	60	PCS-085-FCD48D	PCS-085-FCD48W
	85	55	75	PCS-085-FCD49D	PCS-085-FCD49W
	108	75	100	PCS-108-FCD50D	PCS-108-FCD50W
	135	90	125	PCS-135-FCD51D	PCS-135-FCD51W
201	132	200	PCS-201-FCD54D	PCS-201-FCD54W	
251	160	250	PCS-251-FCD56D	PCS-251-FCD56W	
317	200	300	PCS-317-FCD57D	PCS-317-FCD57W	
361	250	350	PCS-361-FCD58D	PCS-361-FCD58W	
480	315	500	PCS-480-FCD61D	PCS-480-FCD61W	

### Combination Fusible PCS Softstarters include:

- A fused switch with external operating handle
- A 120V control power transformer with fused primary and secondary
- PCS built-in electronic motor overload protection
- PCS built-in SCR bypass/run contactor
- Available in UL Type 12 or 4 Enclosures
- Terminal blocks for remote control devices

D PCS Softstarters

- ① Other UL type enclosures available. Contact your Sprecher + Schuh representative.
- ② See page D18 if ordering factory installed modifications.
- ③ The nominal current rating for the combination package may differ from the controller, based on the horsepower. Consult your Sprecher + Schuh representative.
- ④ Fuse clips accept J-Type fuses. Power fuses are not supplied. See page D29 for Fusible Disconnect amp ratings.
- ⑤ For 380V applications choose softstarter based on FLA, then change the FB code in the catalog number to FG. Example PCS-043-FBD44D becomes PCS-043-FGD44D, which covers 25 HP @ 380V FLA 37.

- ⑥ For outdoor applications, replace "D" in catalog number with an "R". All enclosures are Type-12 with a Drip Shield. For example number PCS-085-FBD47D becomes PCS-085-FBD47R.
- ⑦ Motor FLA rating must fall within the specified current range for unit to operate properly. Special consideration should be given when using a motor with a potentially high starting current (greater than ten times motor FLA) with the PCS in the "Full Voltage" starting mode. The overload setting must be set to the motor FLA regardless if the Overload Function is "OFF" (disabled). Contact Sprecher+Schuh technical support for further guidance.





**Options - Factory Modifications**

Description	Catalog Number
<b>Pushbuttons (2)</b> START and STOP pushbuttons for enclosed softstarters	Add suffix " <b>-3</b> "
<b>Selector Switch</b> Two or three position selector switch for enclosed softstarters "ON-OFF" "HAND-OFF-AUTO"	Add suffix " <b>-6</b> " Add suffix " <b>-7</b> "
<b>Pilot Light</b>  Red pilot light with "RUN" inscription for enclosed softstarters	Add suffix " <b>-1</b> "
<b>Voltmeter</b> (Panelboard) Measures all three phases. Includes switch.	Add suffix " <b>-VM3</b> "
<b>Ammeter</b> (Panelboard) For monitoring all three phases. Includes switch.	Add suffix " <b>-AM3</b> "
<b>Elapsed Time Meter</b> Measures elapsed motor running time	Add suffix " <b>-ETM</b> "



**D**  
PCS Softstarters

**1** When adding Pilot Lights plus other cover controls, add the Pilot Light first. For example; to add a Start-Stop Pushbutton and a Pilot Light, add **-13** at the end of the part number, not **-31**.

**Auxiliary Contact Blocks (1 & 2 Pole) ①**

Contact Block	Description	NO	NC	Contact Arrangement	For use with...	Catalog Number
	<ul style="list-style-type: none"> <li>For side mounting with sequence terminal designations</li> <li>Snap-on design – mounts without tools</li> <li>One block per device only</li> </ul>	1	0		All PCS & PCEC Controllers	PCS-PA-10
		2	0			PCS-PA-20
		0	1			PCS-PA-01
		1	1			PCS-PA-11

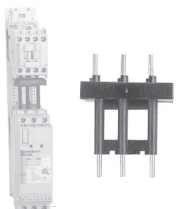
**Accessories**

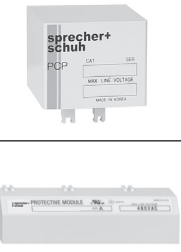
Accessory	Description	For use with...	Catalog Number
 <p><b>PCV-064</b></p>	<p><b>Internal PCS Fan</b></p> <ul style="list-style-type: none"> <li>Attaches directly to PCS Controller</li> <li>Recommended for enclosed PCS-003...37A Controllers</li> <li>Fan is included as standard on PCS-043...480A devices</li> <li>For PCS-108...480A units, separate 120V or 240V single phase is required for fan operation.</li> </ul>	PCS-003...037 PCE-032...064-600V	<b>PCV-064</b>
		PCS-043...085 PCE-074...147-600V	<b>PCV-147</b>
		PCS-108...135 PCE-234-600V	<b>PCV-234</b>
		PCS-201...251	<b>PFV-0251</b>
		PCS-317...480	<b>PFV-0480</b>
	<p><b>Connecting Module</b></p> <ul style="list-style-type: none"> <li>For direct connection of PCS Controller to KT7 Motor Circuit Controller</li> <li>Motor Circuit Controller and PCS Controller must each be mounted</li> <li>See Section F for KT7 Mounting Modules</li> </ul>	KT7-25S to PCS-003...025	<b>PCS-25S-CC25</b>
		KT7-25H to PCS-003...025	<b>PCS-25H-CD25</b>
		KT7-45H to PCS-003...037	<b>PCS-45H-CF45</b>
	<p><b>Connecting Module</b></p> <ul style="list-style-type: none"> <li>For direct connection of PCS Controller to CA7 contactor</li> <li>CA7 Contactor and PCS Controller must each be mounted</li> <li>See Section F for KT7 Mounting Modules</li> </ul>	CA7-9...23 to PCS-003...019	<b>PCS-23-CI23</b>
		CA7-30...37 to PCS-003...037	<b>PCS-37-CI37</b>
	<p><b>600V Protective Module</b></p> <ul style="list-style-type: none"> <li>Protects power components from transient voltage spikes and shunts noise energy away from the controller electronics</li> <li>PCS (3 Lead) Line Connected Applications: Protective modules may be installed on the line and/or load side</li> <li>PCS (6 Lead) Delta Connected Applications: Protective modules must be installed on the line side only</li> <li>Clamping voltage range 705V...1750V, energy rating 290 joules</li> </ul>	PCS-003...037-600V PCE-032...064-600V	<b>PCP-064-600V</b>
		PCS-043...085-600V PCE-074...147-600V	<b>PCP-147-600V</b>
		PCS-108...480 PCE-234-600V	<b>PFV-0480-600V</b>

① One Auxiliary Contact block (one or two pole) may be mounted on the right side of the controller.



### IEC Terminal Covers ①

	Description		Pkg. Qty.	Catalog Number
	IEC line or load terminal covers for 108...135A devices. Dead front protection		1	PFT-0135
	IEC line or load terminal covers for 201...251A devices. Dead front protection			PFT-0251
	IEC line or load terminal covers for 317...480A devices. Dead front protection			PFT-0480

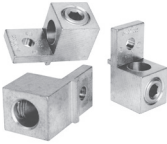

### Terminal Lug Kits (108...480 A)

	Current Rating (A)	Conductor Size	Total No. of Line Controller Terminal Lugs Possible Each Side		Pkg. Qty.	Catalog Number
			Line Side	Load Side		
	108...135	#6...250 MCM AWG 16 mm <sup>2</sup> ...120mm <sup>2</sup>	3	3	3	PNX-1120
201...251		6	6			
317...480	#4...500 MCM AWG 25 mm <sup>2</sup> ...240MM <sup>2</sup>	6	6	PNX-1240		

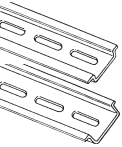
### Accessories

Accessory	Description	For Use With...	Catalog Number
	<b>Remote Reset Solenoid -</b> For remote resetting of the PCS electronic overload	PCS	<b>CMR7- *</b> <i>Replace * with coil code below</i>
	<b>External Reset Button -</b> Used for manually resetting the PCS electronic overload	All PCS Controllers	<b>Use D7 Reset</b> <b>See Section H</b>
	<b>DIN-rail - 2 meter lengths (6' 6")</b>  Top Hat, low profile (price per rail) Top Hat, high profile (price per rail)		<b>3F</b> <b>3AF</b>

### Marking Systems

Component	Description	Pkg. Qty.	Catalog Number
	<b>Label Sheet -</b> 1 sheet with 105 self-adhesive paper labels each, 6 x 17mm	1	<b>CA7-FMS</b>
	<b>Marking Tag Sheet -</b> 1 sheet with 160 perforated paper labels each, 6 x 17mm. To be used with transparent cover.	1	<b>CA7-FMP</b>
	<b>Transparent Cover -</b> To be used with Marking Tag Sheets.	100 ②	<b>CA7-FMC</b>
	<b>Tag Carrier -</b> For marking with Series V7 Clip-on Tags.	100 ②	<b>CA7-FMA2</b>

### CMR7 Remote Reset Coil Codes

AC Coil Code	Voltage Range		
	50 Hz	60 Hz	50 / 60 Hz
<b>24Z</b>	~	~	24V
<b>120</b>	110V	120V	
<b>240</b>	220V	230V	

DC Coil Code	Voltage
<b>24D</b>	24VDC
<b>48D</b>	48VDC
<b>115D</b>	115VDC

① PCS-108...480A units include one terminal cover as standard.

② Minimum order quantity is one package of 100.



**Control Modules**

PCS Rating	For units rated 200...600V AC ④			
	100...240V AC Catalog Number	Qty	24V AC/DC Catalog Number	Qty
108 A	PCS-108	1	PCS-108-024	1
135 A	PCS-135	1	PCS-135-024	1
201 A	PCS-201	1	PCS-201-024	1
251 A	PCS-251	1	PCS-251-024	1
317 A	PCS-317	1	PCS-317-024	1
361 A	PCS-361	1	PCS-361-024	1
480 A	PCS-480	1	PCS-480-024	1

**Power Poles ①**

PCS Rating	For units rated 200...600V AC ④	
	200...600V AC Catalog Number	Qty
108 A	PFL-0108-600V ②	1
135 A	PFL-0135-600V ②	1
201 A	PFL-0201-600V ③	1
251 A	PFL-0251-600V ③	1
317 A	PFL-0317-600V ③	1
361 A	PFL-0361-600V ③	1
480 A	PFL-0480-600V ③	1

Each power pole contains two SCR's and one bypass contactor power pole. The PCS requires three power poles. For example: the replacement power pole for a PCS-0108-600V is PFL-0108-600V

- ① One piece provided per part number.
- ② Part number contains three power poles.
- ③ Part number contains one power pole.
- ④ Control Modules and Power Poles are not replaceable for PCS-003...85.

Standard Features	
Selectable Start Times	2, 5, 10, 15, 20, 25, or 30 s
Selectable Initial Torque	15%, 25%, 35%, and 65% of locked rotor torque
Selectable Current Limit	150%, 250%, 350%, and 450% of full load current
Selectable Kick Start - 450% FLA	0, 0.5, 1.0, or 1.5 s
Selectable Soft Stop	Off, 100%, 200%, or 300% of the start time setting when wired

Electrical Ratings				
	UL/CSA/NEMA	IEC		
Rated Operation Voltage	200...600V AC (+10%, -15%)	500V~ — 500V~		
Rated Insulation Voltage	600V AC	500V~		
Dielectric Withstand	2200V AC	2500V~		
Repetitive Peak	200...600V AC: 1600V	500V~: 1600V		
Operating Frequency	50/60 Hz	50/60 Hz		
Power Circuit	Utilization Category	1...37 A	—	AC-53b: 3.5-15:3585
		43...60 A	—	AC-53b: 4.5-30:1770
		85 A	—	AC-53b: 4.5-30:3570
		108 A	—	AC-53b: 4.5-30:1770
		135 A	—	AC-53b: 3.5-30: 1770
		201...251 A	—	AC-53b: 3.5-30: 1770
		317...480 A	—	AC-53b: 3.5-30: 1770
Number of Poles	Equipment designed for 3-phase only			
Rated Impulse Voltage	6 kV			
DV/DT Protection	1000V/μs			
Overvoltage Category	III			

SCPD Performance		Type 1 ②					
		Non-Time Delay Fuses (K5)		Thermal Magnetic Circuit Breaker		High Capacity Time Delay Class CC/J/L	
SCPD List ①		Max. Standard Available Fault	Max. Standard Fuse (A)	Max. Standard Available Fault	Max. Circuit Breaker (A)	Max. Standard Available Fault	Max. Circuit Fuse (A)
Line Device Operational Current Rating (A)	3	5 kA	12	5 kA	15	70 kA	6
	9	5 kA	30	5 kA	30	70 kA	15
	16	5 kA	60	5 kA	60	70 kA	30
	19	5 kA	70	5 kA	70	70 kA	40
	25	5 kA	100	5 kA	100	70 kA	50
	30	10 kA	110	10 kA	110	70 kA	60
	37	10 kA	125	10 kA	125	70 kA	60
	43	10 kA	150	10 kA	150	70 kA	90
	60	10 kA	225	10 kA	225	70 kA	125
	85	10 kA	300	10 kA	300	70 kA	175
	108	10 kA	400	10 kA	300	70 kA	200
	135	10 kA	500	10 kA	400	70 kA	225
	201	18 kA	600	18 kA	600	70 kA	350
	251	18 kA	700	18 kA	700	70 kA	400
	317	30 kA	800	30 kA	800	69 kA	500
	361	30 kA	1000	30 kA	1000	69 kA	600
	480	42 kA	1200	42 kA	1200	69 kA	800
Delta Device Operational Current Rating (A)	5.1	5 kA	15	5 kA	15	70 kA	10
	16	5 kA	60	5 kA	60	70 kA	30
	27.6	5 kA	70	5 kA	70	70 kA	60
	32.8	5 kA	125	5 kA	125	70 kA	70
	43	5 kA	150	5 kA	150	70 kA	90
	52	10 kA	200	10 kA	200	70 kA	100
	64	10 kA	250	10 kA	250	70 kA	100
	74	10 kA	250	10 kA	250	70 kA	150
	104	10 kA	400	10 kA	300	70 kA	225
	147	10 kA	400	10 kA	400	70 kA	300
	187	10 kA	600	10 kA	500	70 kA	400
	234	10 kA	700	10 kA	700	70 kA	400
	348	18 kA	1000	18 kA	1000	70 kA	600
	435	18 kA	1200	18 kA	1200	69 kA	800
	549	30 kA	1600	30 kA	1600	69 kA	1000
	625	30 kA	1600	30 kA	1600	69 kA	1200
	831	42 kA	1600	30 kA	1600	69 kA	1600
831	42 kA	1600	42 kA	1200	69 kA	1600	

① Consult local codes for proper sizing of short circuit protection.

② Type 1 performance/protection indicates that, under a short-circuit condition, the fused or circuit breaker-protected starter shall cause no danger to persons or installation but may not be suitable for further service without repair or replacement.

**Electrical Ratings**

		UL/CSA/NEMA	IEC
Control Circuit	Rated Operational Voltage (+10%, -15%)	100...240V AC, 24V AC/DC	100...240V AC, 24V AC/DC
	Rated Insulation Voltage	250V	250V-
	Rated Impulse Voltage	2.5 kV	4 kV
	Dielectric Withstand	1500V AC	2000V-
	Overvoltage Category	II	III ①
	Operating Frequency	50/60 Hz	50/60 Hz
	Input on state voltage minimum, during start (IN1, IN2)	85V AC, 19.2V DC / 19.2V AC	
	Input on state current (IN1, IN2)	9.8 mA @120V AC/19.6 mA @ 240V AC, 7.3 mA @ 24V AC/DC	
	Input off state voltage maximum (IN1, IN2)	40V AC, 17V DC / 12V AC	
	Input off state current @ input off state voltage (IN1, IN2)	<10 mA, <12 mA	
Control Power with Fan, during start	3...37 A	215 mA @ 120V AC / 180 mA @ 240V AC, 800 mA @ 24V DC / 660 mA @ 24V AC	
	43...85 A	200 mA @120V AC / 100 mA @240V AC, 700 mA @ 24V AC/DC	
		<b>Fan Power</b>	<b>Control Power</b>
	108...135 A	20 VA	200 mA @120V AC / 120 mA @ 240V AC, 600 mA @24V AC/DC
	201...251 A	40 VA	
317...480 A	60 VA		
Control Power without Fan, during start	3...37 A	205 mA @120V AC / 145 mA @240V AC, 705 mA @ 24V DC / 580 mA @24V AC	
Steady State Heat Dissipation and Overload Current Range	Controller Rating (A)	Steady State Heat Dissipation (W)	
	3	11	
	9	12	
	16	14	
	19	15	
	25	17	
	30	19	
	37	24	
	43	34	
	60	50	
	85	82	
	108	62	
	135	75	
	201	129	
	251	147	
317	174		
361	194		
480	239		
		Overload Current Range (A)	
		1.3	
		3.9	
		5.3...16	
		6.3...19	
		9.2...27.7	
		10...30	
		12.3...37	
		14.3...43	
		20...60	
		28.3...85	
		27...108	
		34...135	
		67...201	
		84...251	
		106...317	
		120...361	
		160...480	

**Auxiliary Contacts**

		UL/CSA/NEMA	IEC
Rated Operational Voltage		250V AC/30V DC	250V~/30V DC
Rated Insulation Voltage		250V	250V~
Rated Impulse Voltage		2.5 kV	4 kV
Dielectric Withstand		1500V AC	2000V~
Overvoltage Category		II	III ①
Operating Frequency		50/60 Hz	50/60 Hz
Utilization Category		D300/D300	AC15
TB-97, -98 (OVL/D/Fault)	Type of Control Circuit	Electromagnetic relay	
	Number of Contacts	1	
	Type of Contacts	Normally Open (N.O.)	
	Type of Current	AC/DC	
	Rated Operational Current (max.)	0.6 A @ 120V ~ and 0.3 A @ 240V-	
	Conventional Thermal Current $I_{th}$	1 A	
	Make/Break VA	432/72	
TB-13, -14 (Normal/Up-to-Speed)	Type of Control Circuit	Electromagnetic relay	
	Number of Contacts	1	
	Type of Contacts	Normally Open (N.O.)	
	Type of Current	AC/DC	
	Rated Operational Current (max.)	0.6 A @ 120V ~ and 0.3 A @ 240V-	
	Conventional Thermal Current $I_{th}$	1 A	
	Make/Break VA	432/72	

① Overvoltage category II, when either control or auxiliary circuit is wired to a SELV or PELV circuit.

Electrical Ratings		
Side-Mount Auxiliary Contacts		
	UL/CSA/NEMA	IEC
Rated Operational Voltage	250V AC/30V DC	250V/30V DC
Rated Insulation Voltage	250V	250V AC
Rated Impulse Voltage	2.5 kV	4 kV
Dielectric Withstand	1500V AC	2000V AC
Overvoltage Category	II	III <sup>①</sup>
Operating Frequency	50/60 Hz	50/60 Hz
	Utilization Category	C300/R150
	Type of Control Circuit	Electromagnetic relay
	Number of Contacts	1
	Type of Contacts	Normally Open (N.O.)
	Type of Current	AC/DC
	Rated Operational Current (max.)	1.5 A @ 120V AC, 0.75A @ 240V AC, 1.17 A @ 24V DC
	Conventional Thermal Current $I_{th}$	2.5 A
	Make/Break VA	1800/180V AC, 28V DC (resistive)
	Type of Control Circuit	B300/R300
	Type of Control Circuit	Electromagnetic relay
	Number of Contacts	1
	Type of Contacts	Normally Open (N.O.)
	Type of Current	AC/DC
	Rated Operational Current (max.)	3 A @ 120V AC, 1.5A @ 240V AC, 1.17 A @ 24V DC
	Conventional Thermal Current $I_{th}$	5 A
	Make/Break VA	3600/360 V AC, 28V DC (resistive)

Environmental	
Operating Temperature Rating	-5...50 °C (23...122 °F) (open) -5...40 °C (23...104 °F) (enclosed)
Storage and Transportation Temperature Range	-25...85 °C (-13...185 °F)
Altitude	2000 m (6560 ft)
Humidity	5...95% (non-condensing)
Pollution Degree	2
Type of Protection	IP2X

Mechanical Ratings			
Resistance to Vibration	Operational	1.0 G Peak, 0.15 mm (0.006 in.) displacement	
	Non-operational	2.5 G Peak, 0.38 mm (0.015 in.) displacement	
Resistance to Shock	Operational	15 G	
	Non-operational	30 G	
Line Power Terminals	Cable Size Tightening Torque	3...37 A	2.5...25 mm <sup>2</sup> (14...4 AWG) 2.3...2.8 N•m (20...25 in-lbs)
		43...85 A	2.5...95 mm <sup>2</sup> (14...3/0 AWG) 11.3...12.4 N•m (100...110 in-lbs)
		108...135 A	16.9 N•m (150 in-lbs)
		201...251 A	Two M10 x 1.5 diameter holes per power pole
		317...480 A	Two M12 x 1.75 diameter holes per power pole
Load Power Terminals	Cable Size Tightening Torque	3...37 A	2.5...16 mm <sup>2</sup> (14...6 AWG) 2.3...2.5 N•m (20...22.5 in-lbs)
		43...85 A	2.5...50 mm <sup>2</sup> (14...1 AWG) 11.3...12.4 N•m (100...110 in-lbs)
		108...135 A	23 N•m (200 in-lbs)
		201...251 A	Two M10 x 1.5 diameter holes per power pole
		317...480 A	Two M12 x 1.75 diameter holes per power pole
Control Terminals	Cable Size Tightening Torque	All	0.2...2.5 mm <sup>2</sup> (24...14 AWG) 0.5...0.9 N•m (4.4...8.0 in-lbs)

Other		
	UL/CSA/NEMA	IEC
EMC Emissions Levels	Conducted Radio Frequency Emissions	—
	Radiated Emissions	—
EMC Immunity Levels	Electrostatic Discharge	4 kV Contact and 8 kV Air Discharge
	Radio Frequency Electromagnetic Field	—
	Fast Transient	—
	Surge Transient	—

① Overvoltage category II, when either control or auxiliary circuit is wired to a SELV or PELV circuit.

**Overload Relay Trip Curves**

— Hot — Cold

**Trip Class 10**

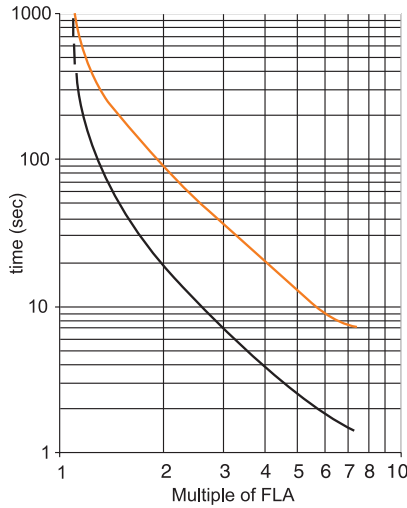

**Trip Class 15**

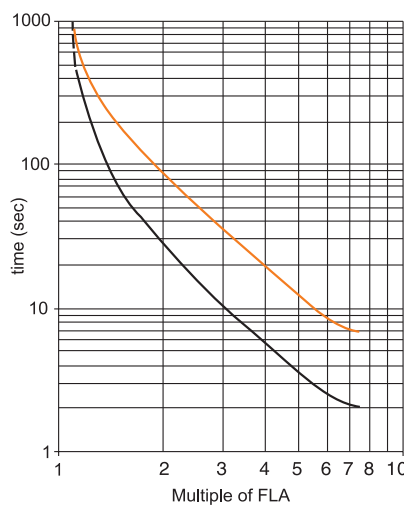

**Trip Class 20**

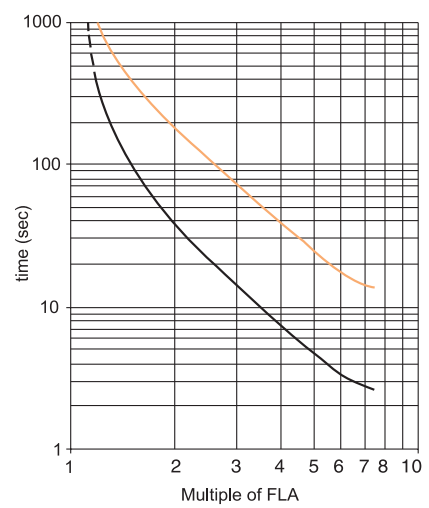

**Starts per Hour Curves**

PCS Controller - Starts per hour  
40C, 100% duty cycle, 10 sec., 350%, no fan

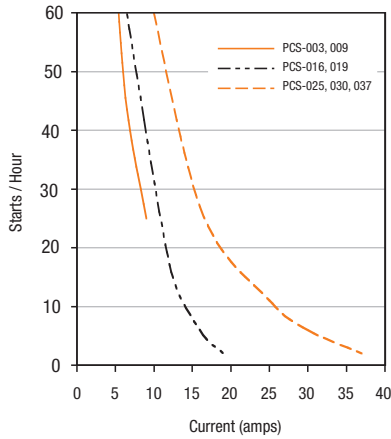

PCS Controller - Starts per hour  
40C, 100% duty cycle, 10 sec., 350%, with fan

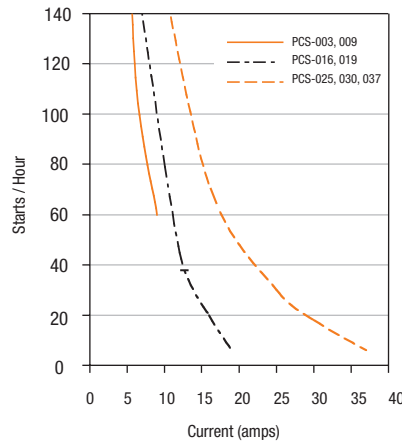

PCS Controller - Starts per hour  
40C, 100% Duty Cycle, 20sec, 350% (with standard fan)

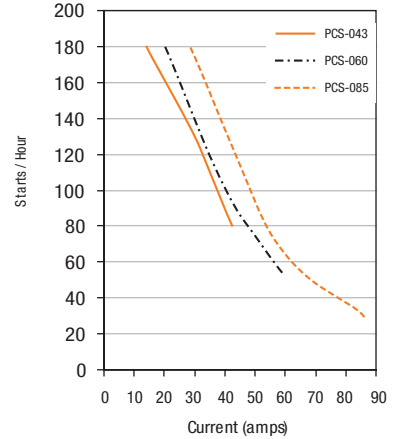

PCS Controller Starts per hour (108-135A)  
40C, 100% Duty Cycle, 20 sec, 350% (with standard fan)

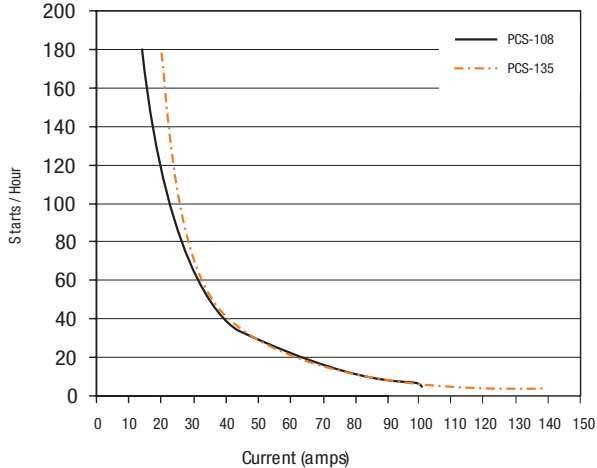

PCS Controller Starts per hour (201...480 A)  
40C, 100% Duty Cycle, 20 sec, 350% (with standard fan)

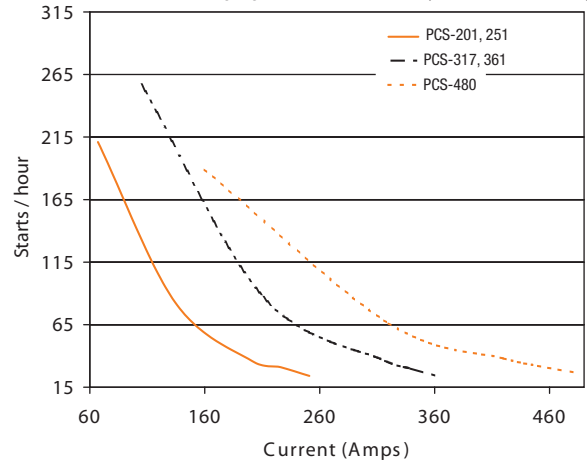

**D**  
PCS Softstarters



**Two Wire Configuration**

**Line Connected ①**

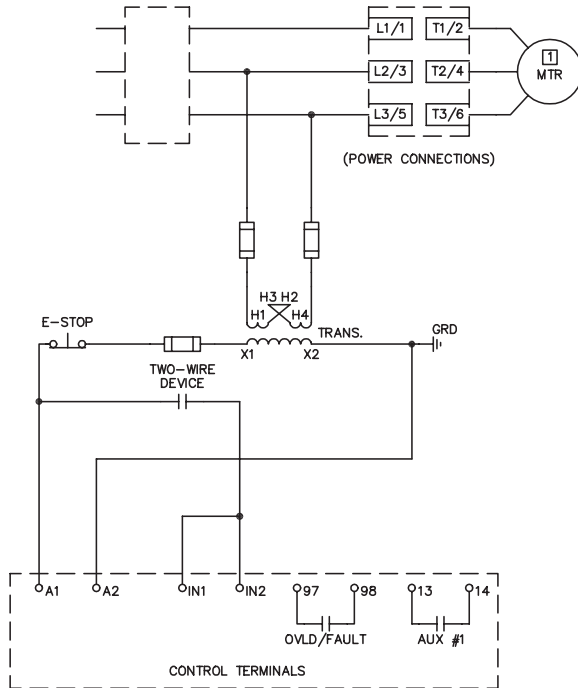

**Delta Connected ①**

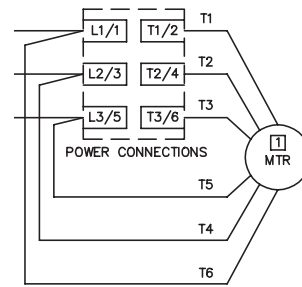

- ① Line or Delta Connected selection are determined by the customer.
- PCS DIP Switch #15 "ON": PCS set for Line Connected Motors
  - PCS DIP Switch #15 "OFF": PCS set for Delta Connected Motors

**Three Wire Configuration**

**Line Connected ①**

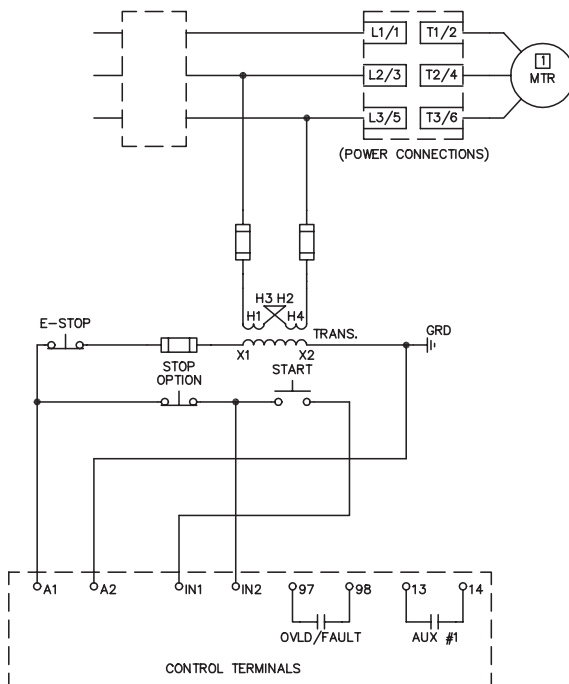

**Delta Connected ①**

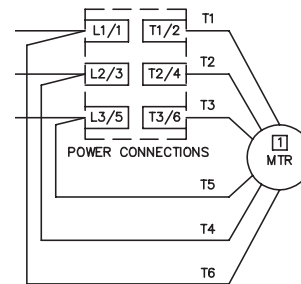

- ① Line or Delta Connected selection are determined by the customer.
- PCS DIP Switch #15 "ON": PCS set for Line Connected Motors
  - PCS DIP Switch #15 "OFF": PCS set for Delta Connected Motors

Isolation Contactor Configuration

Line Connected ①

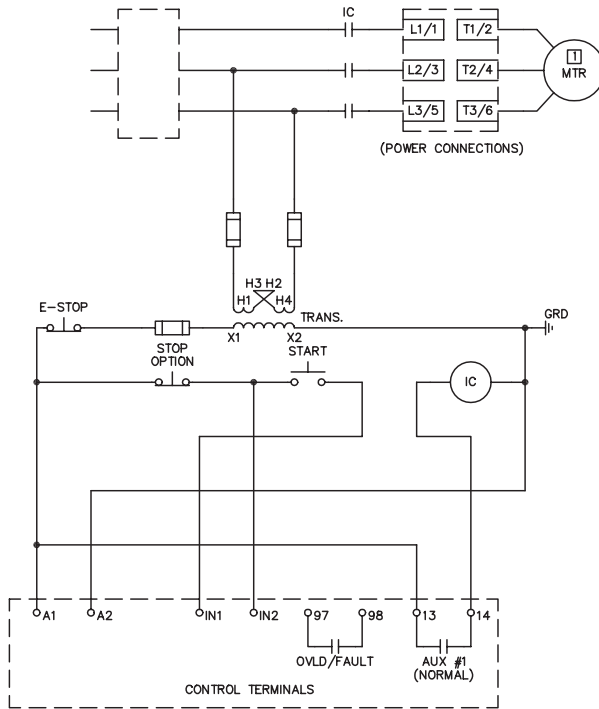

Delta Connected ①

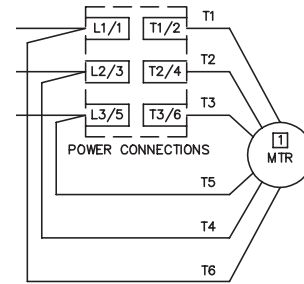

- ① Line or Delta Connected selection are determined by the customer.
- PCS DIP Switch #15 "ON": PCS set for Line Connected Motors
  - PCS DIP Switch #15 "OFF": PCS set for Delta Connected Motors

Reversing Configuration

Line Connected ①

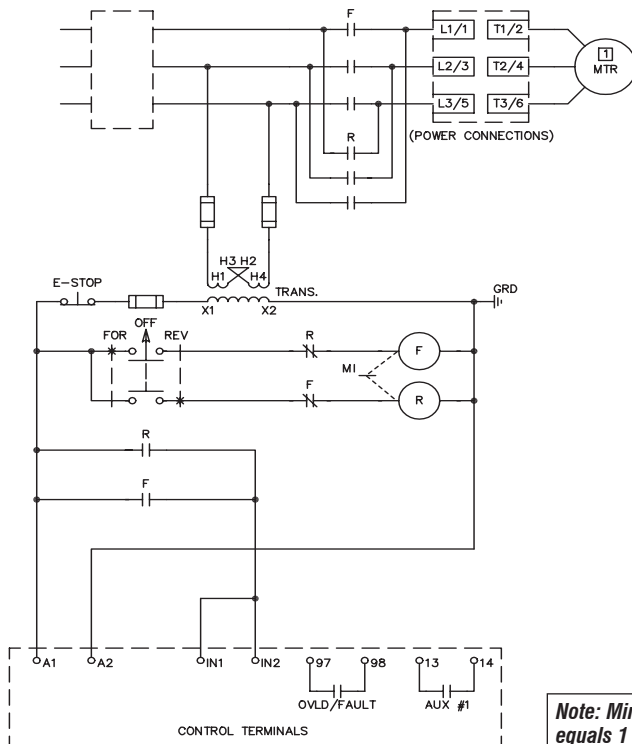

Delta Connected ①

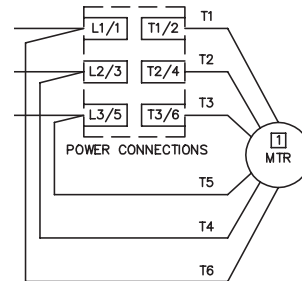

- ① Line or Delta Connected selection are determined by the customer.
- PCS DIP Switch #15 "ON": PCS set for Line Connected Motors
  - PCS DIP Switch #15 "OFF": PCS set for Delta Connected Motors

*Note: Minimum off time equals 1 second*

**PCS Softstarter Controller**

Dimensions are in millimeters (inches). Dimensions not intended for manufacturing purposes.

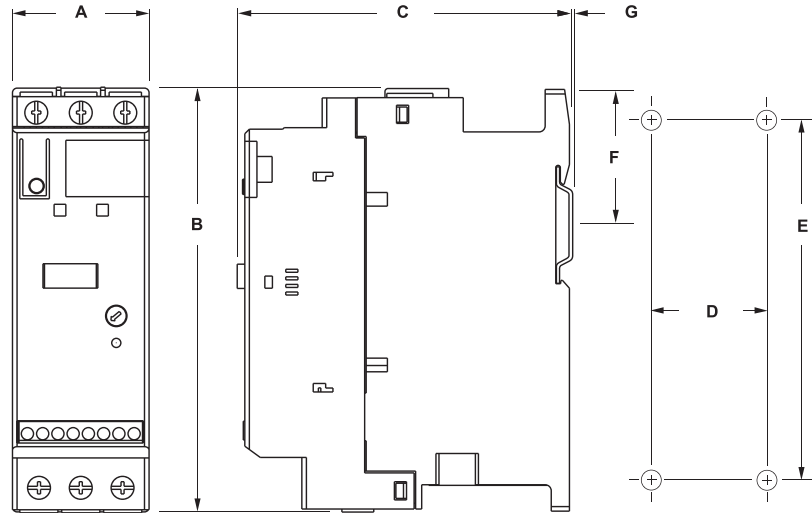

Controller	A	B	C	D	E	F	G	Mounting Hole Size	Weight (kg (lbs))
3...37A	44.8 (1-49/64)	139.7 (5-1/2)	100 (4-21/64)	35 (1-3/8)	132 (5-13/64)	46.4 (1-13/16)	2 (1/16)	4.6 (0.18)	0.86 (1.9)
43...85A	72 (2-26/32)	206 (8-1/8)	130 (5-1/8)	55 (2-5/32)	198 (7-25/32)	102 (4)	2 (1/16)	5.3 (0.21)	2.25 (5.0)
108...135A	196.4 (7.74)	443.7 (17.47)	205.2 (8.08)	166.6 (6.56)	367 (14.45)	~	~	7.5 (0.295)	15 (33)
201...251	225 (8.86)	560 (22.05)	265.3 (10.45)	150 (5.91)	504.1 (19.85)	~	~	11.5 (0.45)	30.4 (67)
317...480	290 (11.42)	600 (23.62)	298 (11.73)	200 (7.87)	539 (21.23)	~	~	11.5 (0.45)	45.8 (101)

**Minimum Enclosure Size**

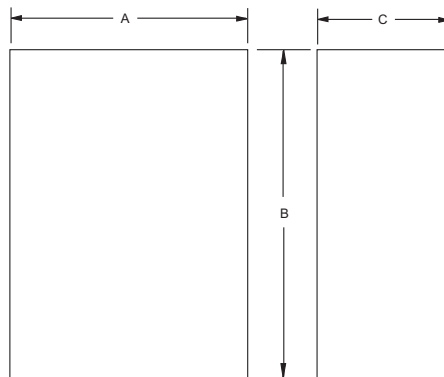

Controller	Height B	Width A	Depth C	Fan Requirements
3...37 A	305 (12)	224 (9)	152 (6)	none
43...85 A	406 (16)	305 (12)	203 (8)	none
108...135 A	762 (30)	610 (24)	305 (12)	none
201...251 A	965 (38)	762 (30)	356 (14)	none
317...480 A	1295 (51)	914 (36)	356 (14)	none

### Enclosed Type Line-Connected Controllers

**IMPORTANT NOTE:**

Factory installed options may affect enclosure size requirements. Exact dimensions can be obtained after order entry. Consult your local Sprecher + Schuh representative.

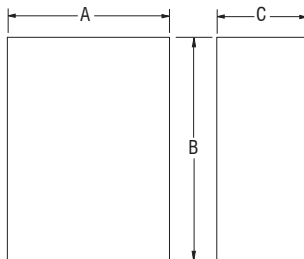

Dimensions are in millimeters (inches). Dimensions not intended for manufacturing purposes.

Controller Rating (A)	Disconnect Rating	IP65 (Type 4/12)		
		B Height	A Width	C Depth
<b>Non-Combination Controller</b>				
3	—	356 (14)	305 (12)	152 (6)
9	—	356 (14)	305 (12)	152 (6)
16	—	356 (14)	305 (12)	152 (6)
25	—	356 (14)	305 (12)	152 (6)
30	—	356 (14)	305 (12)	152 (6)
37	—	356 (14)	305 (12)	152 (6)
43	—	406 (16)	356 (14)	203 (8)
60	—	406 (16)	356 (14)	203 (8)
85	—	406 (16)	356 (14)	203 (8)
108	—	762 (30)	610 (24)	305 (12)
135	—	762 (30)	610 (24)	305 (12)
201	—	914 (36)	762 (30)	406 (16)
251	—	914 (36)	762 (30)	406 (16)
317	—	1524 (60)	914 (36)	406 (16)
361	—	1524 (60)	914 (36)	406 (16)
480	—	1524 (60)	914 (36)	406 (16)
<b>Combination Controllers with Fusible Disconnect</b>				
3	30 A/J	508 (20)	406 (16)	203 (8)
9	30 A/J	508 (20)	406 (16)	203 (8)
16	30 A/J	508 (20)	406 (16)	203 (8)
25	30 A/J	508 (20)	406 (16)	203 (8)
30	60 A/J	508 (20)	406 (16)	203 (8)
37	60 A/J	508 (20)	406 (16)	203 (8)
43	60 A/J	610 (24)	508 (20)	203 (8)
60	100 A/J	610 (24)	508 (20)	254 (10)
85 ①	100 A/J	610 (24)	508 (20)	254 (10)
85 ②	200 A/J	762 (30)	610 (24)	305 (12)
108	200 A/J	914 (36)	762 (30)	406 (16)
135	200 A/J	914 (36)	762 (30)	406 (16)
201	400 A/J	1219 (48)	914 (36)	406 (16)
251	400 A/J	1219 (48)	914 (36)	406 (16)
317	600 A/J	1524 (60)	914 (36)	406 (16)
361	600 A/J	1524 (60)	914 (36)	406 (16)
480	600 A/J	1524 (60)	914 (36)	406 (16)
<b>Combination Controllers with Circuit Breaker</b>				
3	15 A	508 (20)	406 (16)	203 (8)
9	15 A	508 (20)	406 (16)	203 (8)
16	20 A	508 (20)	406 (16)	203 (8)
25	30 A	508 (20)	406 (16)	203 (8)
30	40 A	508 (20)	406 (16)	203 (8)
37	50 A	508 (20)	406 (16)	203 (8)
43	80 A	610 (24)	508 (20)	203 (8)
60	100 A	610 (24)	508 (20)	254 (10)
85	125 A	610 (24)	508 (20)	254 (10)
108	175 A/175 A Plug	914 (36)	762 (30)	406 (16)
135	225 A/225 A Plug	914 (36)	762 (30)	406 (16)
201	300 A/300 A Plug	1219 (48)	914 (36)	406 (16)
251	400 A/400 A Plug	1219 (48)	914 (36)	406 (16)
317	600 A/600 A Plug	1524 (60)	914 (36)	406 (16)
361	600 A/600 A Plug	1524 (60)	914 (36)	406 (16)
480	800 A/800 A Plug	1524 (60)	914 (36)	406 (16)

① Dimensions for FHD-43, FAD-44, FBD-47, and FCD-48.

② Dimensions for FHD-44, FAD-45, FBD-48, and FCD-49.





# PF Controllers

The Intelligent Controller with extensive starting and stopping configurations up to 1000HP (3-wire), 1400HP (6-wire)



PF Control module with standard built in keypad and backlit LCD display

The PF Softstarter Controller provides intelligence, unmatched performance, flexibility, and diagnostics in a modular compact design for controlling either a standard squirrel-cage induction motor or a star-delta motor. Seven standard, and two optional modes of operation are available within a single controller.

## Standard Modes of Operation

- Soft Start with selectable kick start
- Current Limit Starting
- Dual ramp start
- Full voltage starting
- Linear speed acceleration
- Preset slow speed
- Soft stop

## Optional Modes of Operation

- Pump Control
- Brake Control - Smart Motor Brake, Accu-stop and Slow Speed with Braking

## Product Features

- Built-in SCR Bypass/Run Contactor
- Built in Electronic Motor Overload Protection
- CT on each phase
- LCD Display
- Keypad programming
- Four programming Auxiliary Contacts

The PF Softstarter is available for motors rated 1...1,250A, 200...600V AC, 50 and 60Hz. In addition to motors, the PF Softstarter can be used to control resistive loads.

## Modular and Compact Softstarter

The PF Softstarter reduces both product size and the total cost to the customer. As standard, the PF Softstarter includes electronic overload, integral bypass and motor starting capabilities for both star-delta and standard squirrel-cage induction motors, advanced protection and diagnostics in a compact maintainable modular, cost-effective package.



## Large or small HP and options for any application

The basic PF Controller combines large horsepower capacity with the most popular starting modules (up to 1,000HP @ 460V, 3-wire). Even in middle and low horsepower applications, PF Softstarters can be configured to provide exactly the right starting and stopping profile (see descriptions on following pages).

## Precise programming set-up with built-in keypad & LCD display

The PF Controller comes equipped with a built-in keypad and LCD display for programming the controller parameter settings for the specific industrial application. The three-line 16-character backlit LCD display provides parameter identification using clear informative text. Parameters are arranged in an organized four-level menu structure for ease of programming and fast access to parameters which allows the PF Softstarters set-up to be performed quickly and easily.

## Product Overview

### Modular Design

The PF Softstarter provides intelligence, unmatched performance, flexibility and diagnostics in a modular compact design for controlling either a standard squirrel-cage induction motor or a star-delta motor.

### Compact Size

The PF Softstarter integrates a bypass to minimize heat generation during run time. The bypass automatically closes when the motor reaches its nominal speed, resulting in a cooler-running component and reduction in enclosure size.

### Current Range - 16 Models

Product Rating	Line Current	Delta Current
5	5	9
25	25	43
43	43	74
60	60	104
85	85	147
108	108	187
135	135	234
201	201	348
251	251	435
317	317	549
361	361	625
480	480	831
625	625	850
780	780	900
970	970	1200
1250	1250	1600

### Voltage Range

200...600V AC, 50/60 Hz

### Control Range

100...240V AC or 24V AC/DC

### Starting Modes

	PFS Standard	PFB Pump Control	PFD Braking Control
Soft Start	X	X	X
Soft Stop	X		
Current Limit	X	X	X
Full Voltage	X	X	X
Kick Start	X	X	X
Preset Slow Speed	X		X
Linear Speed Start and Stop	X		
Dual Ramp	X		
Pump Start and Stop		X	
Smart Motor Brake			X
Accu-Stop			X
Slow Speed with Braking			X

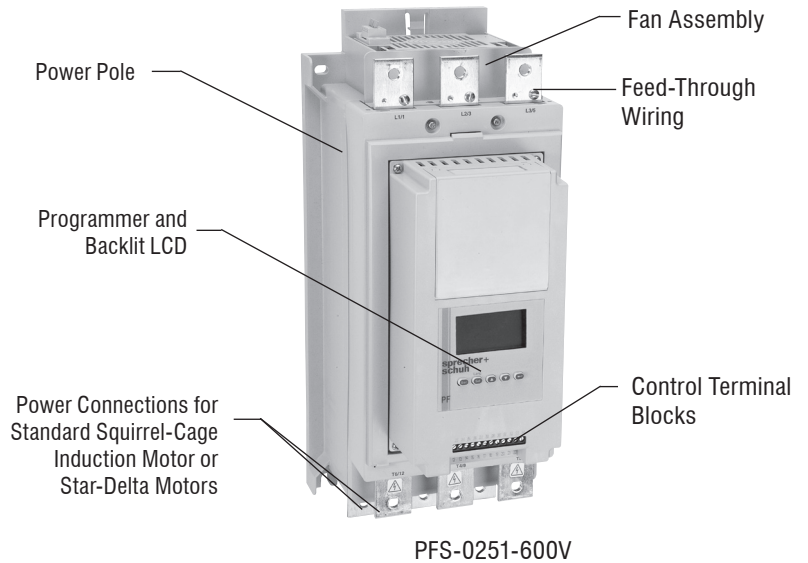

PFS-0251-600V

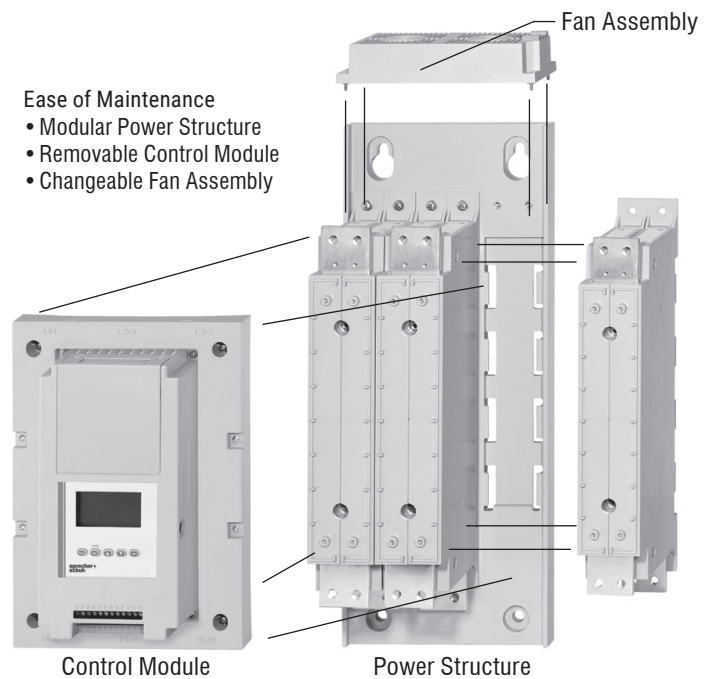

Control Module

Power Structure

**Product Features**

**Overload**

- Flexibility in Trip Class (10,15, 20, 30, Off)
- Reset Operation (Manual or Automatic)

**Diagnostics**

- PTC
- Line Fault
- Voltage Imbalance
- Undervoltage
- Overtemperature
- Overload
- Ground Fault
- Power Loss
- Phase Reversal
- Overvoltage
- Open Gate
- Excessive Starts per Hour

**Configurable Auxiliary Contacts - 4**

- Normal, Up-to-speed, External bypass, Fault, Alarm
- N.O. or N.C.

**Motor Control**

- Standard Squirrel-Cage Induction Motor
- Start-Delta Motor

**Metering**

- Three-phase Currents
- Power in kW
- Motor Thermal
- Capacity Usage
- Elapsed Time of Motor Operation
- Three-phase voltages
- Power Usage in kWh
- Power Factor of the Running Motor

**I/O**

- 2 Inputs
- 4 Configurable Auxiliary Contacts

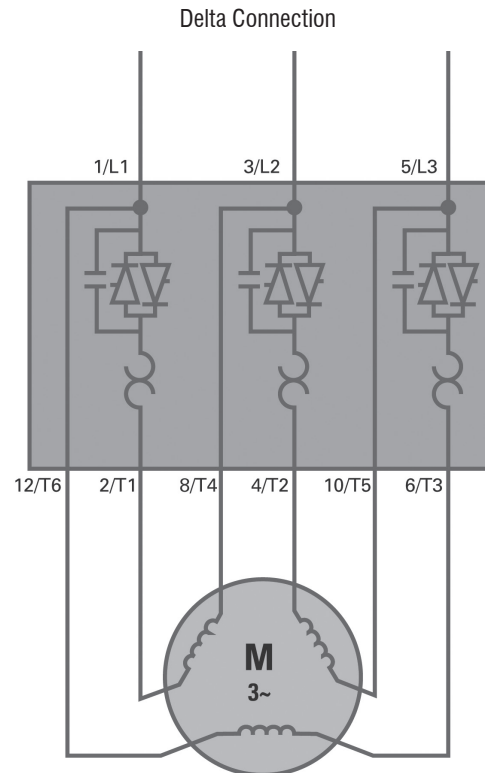
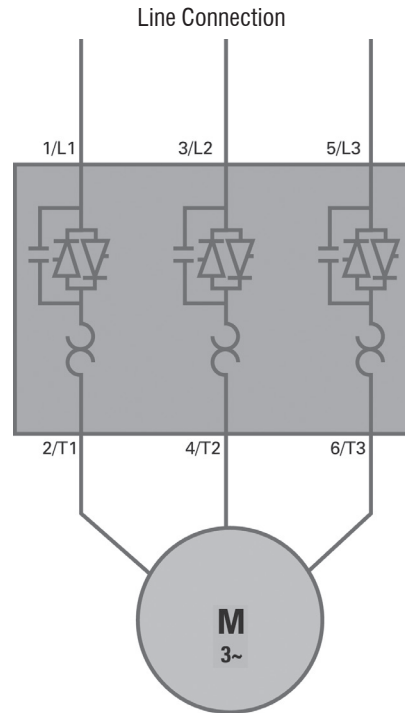

**D**  
PFS Softstarters

**Modes of Operation (Standard PFS)**

**D**  
PFS Softstarters

**Soft Start**

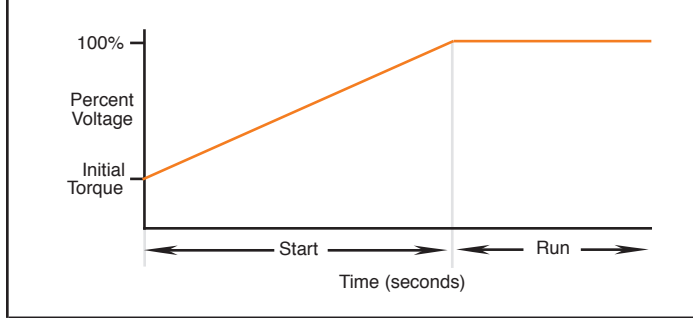

This method covers the most general applications. The motor is given an initial torque setting, which is user adjustable. From the initial torque level, the output voltage to the motor is steplessly increased during the acceleration ramp time, which is user adjustable.

**Soft Start with Selectable Kickstart**

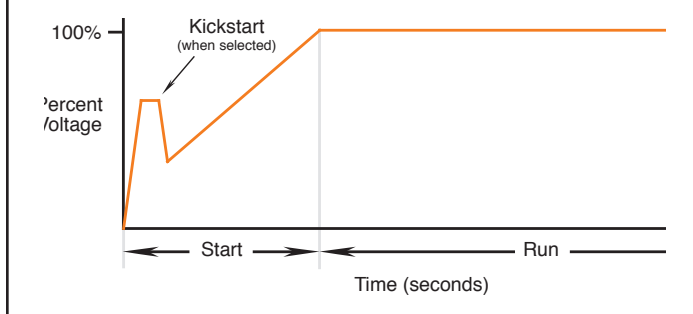

The kickstart feature provides a boost at startup to break away loads that may require a pulse of high torque to get started. It is intended to provide a current pulse, for a selected period of time.

**Current Limit Starting**

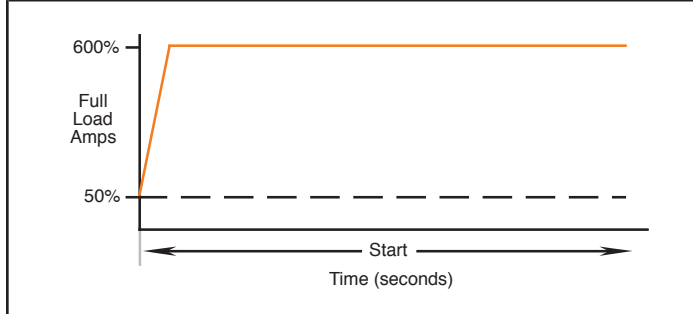

This method provides current limit start and is used when it is necessary to limit the maximum starting current. The starting current is user adjustable. The current limit starting time is user adjustable.

**Dual Ramp Start**

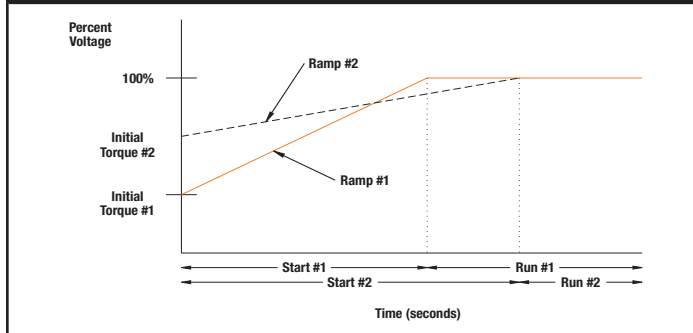

This starting method is useful on applications with varying loads, starting torque, and start time requirements. Dual Ramp Start offers the user the ability to select between two separate start profiles with separately adjustable ramp times and initial torque settings.

**Modes of Operation (Standard PFS)**

Full Voltage Start	
	<p>This method is used in applications requiring cross-the-line starting. The PF controller performs like a solid-state contactor. Full inrush current and locked-rotor torque are realized. The PF may be programmed to provide full voltage start in which the output voltage to the motor reaches full voltage in 1/4 second.</p>
Linear Speed Acceleration	
	<p>With this type of acceleration mode, a closed-loop feedback system maintains the motor acceleration at a constant rate. The required feedback signal is provided by a DC tachometer coupled to the motor (tachometer supplied by user 0-5V DC, 4.5V DC = 100% speed). Kickstart is available with this mode.</p>
Preset Slow Speed	
	<p>This method can be used on applications that require a slow speed for positioning material. The Preset Slow Speed can be set for either Low, 7% of base speed, or High, 15% of base speed. Reversing is also possible through programming. Speeds provided during reverse operation are Low, 10% of base speed, or High, 20% of base speed.</p>
Soft Stop ①	
	<p>The Soft Stop option can be used in applications requiring an extended stop time. The voltage ramp down time is user adjustable from 0 to 120 seconds. The load will stop when the voltage drops to a point where the load torque is greater than the motor torque.</p>

**D**  
PFS Softstarters

① Not intended to be used as an emergency stop. Refer to the applicable standards for emergency stop requirements.



**Optional Modes of Operation**

**D**  
PFS Softstarters

**Pump Control - Start and Stop (Option "PFB") ①**

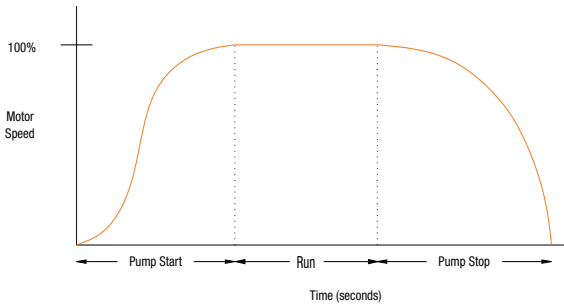

This option is used to reduce surges during the starting and stopping of a centrifugal pump by smoothly accelerating and decelerating the motor. The microprocessor analyzes the motor variables and generates commands which control the motor and reduce the possibility of surges occurring in the system. The pump control module also provides a built-in anti-backspin timer.

**Smart Motor Brake (Option "PFD") ①**

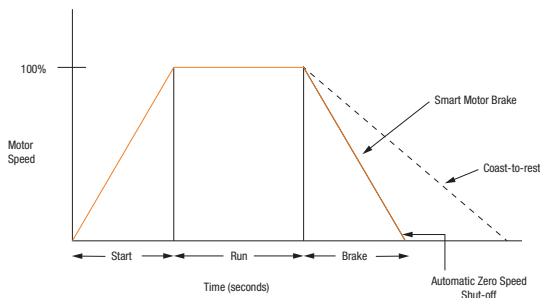

This option provides motor braking for applications that require the motor to stop faster than a coast to rest. Braking control, with automatic zero speed shut off, is fully integrated into the compact design of the PF controller. This design facilitates a clean, straight forward installation and eliminates the requirement for additional hardware such as braking contactors, resistors, timers, and speed sensors. The microprocessor based braking system applies braking current to a standard squirrel-cage induction motor. The strength of the braking current is programmable from 150...400% of full-load current.

**Accu-Stop (Option "PFD") ①**

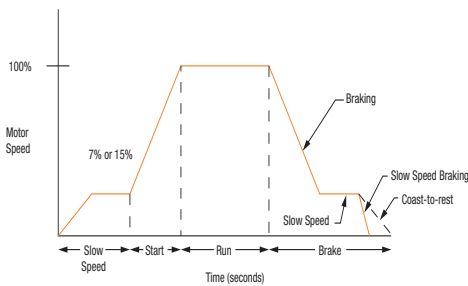

This option is used in applications requiring controlled position stopping. During stopping, braking torque is applied to the motor until it reaches preset slow speed (7% or 15% of rated speed) and holds the motor at this speed until a stop command is given. Braking torque is then applied until the motor reaches zero speed. Braking current is programmable from 0...400% of full-load current. Slow Speed Current is programmable from 0...450% of full-load current. Slow speed can be programmed for either 7% (low) or 15% (high).

**Slow Speed with Braking (Option "PFD") ①**

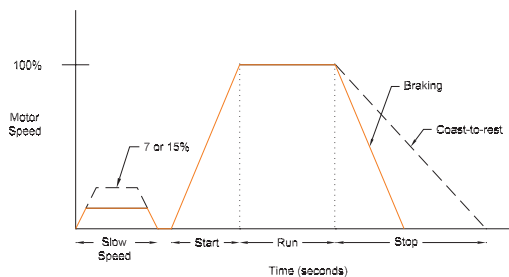

Slow Speed with Braking is used on applications that require slow speed (in the forward direction) for positioning or alignment and also require braking control to stop. Slow speed adjustments are 7% (low) or 15% (high) of rated speed. Slow speed acceleration current is adjustable from 0...450%. Slow speed running current is adjustable from 0...450% of full-load current. Braking current is adjustable from 0...400%.

① Not intended to be used as an emergency stop. Refer to the applicable standards for emergency stop requirements.

## Description of Features

### Electronic Motor Overload Protection

The PF Softstarter controller incorporates, as standard, electronic motor overload protection. This overload protection is accomplished electronically with an  $I^2t$  algorithm. When coordinated with the proper short circuit protection, overload protection is intended to protect the motor, motor controller, and power wiring against overheating caused by excessive overcurrent. The PF Softstarter controller meets applicable requirements as a motor overload protective device. The controller's overload protection is programmable, providing the user with flexibility. The overload trip class consists of either OFF, 10, 15, 20 or 30 protection. The trip current is programmed by entering the motor full-load current rating, service factor, and selecting the trip class. Thermal memory is included to accurately model motor operating temperature. Ambient insensitivity is inherent in the electronic design of the overload.

### Stall Protection and Jam Detection

Motors can experience locked-rotor currents and develop high torque levels in the event of a stall or a jam. These conditions can result in winding insulation breakdown or mechanical damage to the connected load. The PF Softstarter controller provides both stall protection and jam detection for enhanced motor and system protection. Stall protection allows the user to program a maximum stall protection delay time from 0...10 seconds. The stall protection delay time is in addition to the programmed start time and begins only after the start time has timed out. If the controller senses that the motor is stalled, it will shut down after the delay period has expired. Jam detection allows the user to determine the motor jam detection level as a percentage of the motor's full-load current rating. To prevent nuisance tripping, a jam detection delay time, from 0.0...99.0 seconds, can be programmed. This allows the user to select the time delay required before the PF Softstarter controller will trip on a motor jam condition. The motor current must remain above the jam detection level during the delay time. Jam detection is active only after the motor has reached full speed.

### Underload Protection

Utilizing the underload protection of the PF Softstarter controller, motor operation can be halted if a drop in current is sensed. The PF Softstarter controller provides an adjustable underload trip setting from 0...99% of the programmed motor full-load current rating with an adjustable trip delay time of 0...99 seconds.

### Undervoltage Protection

The PF Softstarter controller's undervoltage protection will halt motor operation if a drop in the incoming line voltage is detected. The undervoltage trip level is adjustable as a percentage of the programmed line voltage, from 0...99%. To eliminate nuisance trips, a programmable undervoltage trip delay time of 0...99 seconds can also be programmed. The line voltage must remain below the undervoltage trip level during the programmed delay time.

### Overvoltage Protection

If a rise in the incoming line voltage is detected, the PF Softstarter controller's overvoltage protection will halt motor operation. The overvoltage trip level is adjustable as a percentage of the programmed line voltage, from 0...199%. To eliminate nuisance trips, a programmable overvoltage trip delay time of 0...99 seconds can also be programmed. The line voltage must remain above the overvoltage trip level during the programmed delay time.

### Voltage Unbalance Protection

Voltage unbalance is detected by monitoring the 3-phase supply voltage

magnitudes in conjunction with the rotational relationship of the three phases. The controller will halt motor operation when the calculated voltage unbalance reaches the user-programmed trip level. The voltage unbalance trip level is programmable from 0...25% unbalance.

### Excessive Starts Per Hour

The PF Softstarter controller allows the user to program the allowed number of starts per hour (up to 99). This helps eliminate motor stress caused by repeated starting during a short time period.

### Metering

Power monitoring parameters include:

- 3-phase current
- 3-phase voltage
- Power in kW
- Power usage in kWh
- Power factor
- Motor thermal capacity usage
- Elapsed time

Note: The motor thermal capacity usage allows the user to monitor the amount of overload thermal capacity usage before the PF Softstarter controller's built-in electronic overload trips.

### LCD Display

The PF Softstarter controller's three-line 16-character backlit LCD display provides parameter identification using clear, informative text. Controller set up can be performed quickly and easily without the use of a reference manual. Parameters are arranged in an organized four-level menu structure for ease of programming and fast access to parameters.

### Keypad Programming

Programming of parameters is accomplished through a five-button keypad on the front of the PF Softstarter controller. The five buttons include up and down arrows, an Enter button, a Select button, and an Escape button. The user needs only to enter the correct sequence of keystrokes for programming the PF Softstarter controller.

### Auxiliary Contacts

Four fully programmable hard contacts are furnished as standard with the PF Softstarter controller:

Aux #1, Aux #2, Aux #3, Aux #4:

- N.O./N.C.
- Normal/Up-to-Speed/External Bypass/Fault/Alarm

### Ground Fault Input

The PF Softstarter can monitor for ground fault conditions. An external core balance current transformer is required for this function.

### Tach Input

A motor tachometer is required for the Linear Speed Start mode. Please see the Specifications section page D49 for tachometer characteristics.

### PTC Input

A motor PTC input can be monitored by the PF Softstarter. In the event of a fault, the PF Softstarter will shut down and indicate a motor PTC fault.

### Open Type Controller - Line Connected ①⑤

Rated Voltage [V AC]	Motor Current (Amps) ②	Max. kW 50 Hz	Max. Hp 60 Hz ③	100...240V AC 50/60Hz	24V AC/DC
				Control Voltage ④	Control Voltage ④
				Catalog Number	Catalog Number
200/208	1...5	~	1	PFS-0005-600V	PFS-0005-600V-024
	5...25	~	5	PFS-0025-600V	PFS-0025-600V-024
	8.6...43	~	10	PFS-0043-600V	PFS-0043-600V-024
	12...60	~	15	PFS-0060-600V	PFS-0060-600V-024
	17...85	~	25	PFS-0085-600V	PFS-0085-600V-024
	27...108	~	30	PFS-0108-600V	PFS-0108-600V-024
	34...135	~	40	PFS-0135-600V	PFS-0135-600V-024
	67...201	~	60	PFS-0201-600V	PFS-0201-600V-024
	84...251	~	75	PFS-0251-600V	PFS-0251-600V-024
	106...317	~	100	PFS-0317-600V	PFS-0317-600V-024
	120...361	~	125	PFS-0361-600V	PFS-0361-600V-024
	160...480	~	150	PFS-0480-600V	PFS-0480-600V-024
	208...625	~	200	PFS-0625-600V-120 ⑥	~
	260...780	~	250	PFS-0780-600V-120 ⑥	~
323...970	~	350	PFS-0970-600V-120 ⑥	~	
416...1250	~	400	PFS-1250-600V-120 ⑥	~	
230	1...5	1.1	1	PFS-0005-600V	PFS-0005-600V-024
	5...25	5.5	7.5	PFS-0025-600V	PFS-0025-600V-024
	8.6...43	11	15	PFS-0043-600V	PFS-0043-600V-024
	12...60	15	20	PFS-0060-600V	PFS-0060-600V-024
	17...85	22	30	PFS-0085-600V	PFS-0085-600V-024
	27...108	30	40	PFS-0108-600V	PFS-0108-600V-024
	34...135	37	50	PFS-0135-600V	PFS-0135-600V-024
	67...201	55	75	PFS-0201-600V	PFS-0201-600V-024
	84...251	75	100	PFS-0251-600V	PFS-0251-600V-024
	106...317	90	125	PFS-0317-600V	PFS-0317-600V-024
	120...361	110	150	PFS-0361-600V	PFS-0361-600V-024
	160...480	132	200	PFS-0480-600V	PFS-0480-600V-024
	208...625	200	250	PFS-0625-600V-120 ⑥	~
	260...780	250	300	PFS-0780-600V-120 ⑥	~
323...970	315	400	PFS-0970-600V-120 ⑥	~	
416...1250	400	500	PFS-1250-600V-120 ⑥	~	

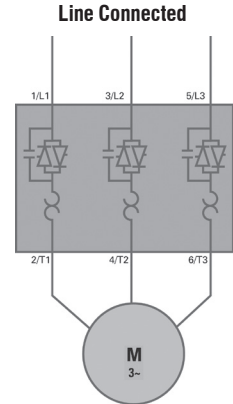

D PFS Softstarters

- ① Controllers rated 108 A and greater are not equipped with line and load terminal lugs. See page D49 for terminal lug kits.
- ② Motor FLA rating must fall within specified current range for unit to operate properly. Special consideration should be given when using a motor with a potentially high starting current (greater than ten times motor FLA) with the PF in the "Full Voltage" starting mode. Contact Sprecher+Schuh technical support for further guidance.

- ③ Hp ratings at motor terminal voltages for 200, 230, 460, and 575 line volts, respectively.
- ④ Separate 120V or 240V single phase is required for PF fan operation.
- ⑤ See page D48 if ordering factory installed PFB Pump Control or PFD Smart Motor Bake Control Modules, or other options.
- ⑥ 110/120V control power only. For 230V control power only, change catalog number suffix "-120" to "-230".

**Open Type Controller - Line Connected ①⑤**

Rated Voltage [V AC]	Motor Current (Amps) ②	Max. kW 50 Hz	Max. Hp 60 Hz ③	100...240V AC 50/60Hz Control Voltage ④	24V AC/DC Control Voltage ④
				Catalog Number	Catalog Number
400/415/460	1...5	2.2	3	PFS-0005-600V	PFS-0005-600V-024
	5...25	11	15	PFS-0025-600V	PFS-0025-600V-024
	8.6...43	22	30	PFS-0043-600V	PFS-0043-600V-024
	12...60	30	40	PFS-0060-600V	PFS-0060-600V-024
	17...85	45	60	PFS-0085-600V	PFS-0085-600V-024
	27...108	55	75	PFS-0108-600V	PFS-0108-600V-024
	34...135	75	100	PFS-0135-600V	PFS-0135-600V-024
	67...201	110	150	PFS-0201-600V	PFS-0201-600V-024
	84...251	132	200	PFS-0251-600V	PFS-0251-600V-024
	106...317	160	250	PFS-0317-600V	PFS-0317-600V-024
	120...361	200	300	PFS-0361-600V	PFS-0361-600V-024
	160...480	250	400	PFS-0480-600V	PFS-0480-600V-024
	208...625	355	500	PFS-0625-600V-120 ⑥	~
	260...780	450	600	PFS-0780-600V-120 ⑥	~
323...970	560	800	PFS-0970-600V-120 ⑥	~	
416...1250	710	1000	PFS-1250-600V-120 ⑥	~	
500/575	1...5	2.2	3	PFS-0005-600V	PFS-0005-600V-024
	5...25	15	20	PFS-0025-600V	PFS-0025-600V-024
	8.6...43	22	40	PFS-0043-600V	PFS-0043-600V-024
	12...60	37	50	PFS-0060-600V	PFS-0060-600V-024
	17...85	55	75	PFS-0085-600V	PFS-0085-600V-024
	27...108	75	100	PFS-0108-600V	PFS-0108-600V-024
	34...135	90	125	PFS-0135-600V	PFS-0135-600V-024
	67...201	132	200	PFS-0201-600V	PFS-0201-600V-024
	84...251	160	250	PFS-0251-600V	PFS-0251-600V-024
	160...317	200	300	PFS-0317-600V	PFS-0317-600V-024
	120...361	250	350	PFS-0361-600V	PFS-0361-600V-024
	160...480	315	500	PFS-0480-600V	PFS-0480-600V-024
	208...625	450	600	PFS-0625-600V-120 ⑥	~
	260...480	560	800	PFS-0780-600V-120 ⑥	~
323...970	710	1000	PFS-0970-600V-120 ⑥	~	
416...1250	900	1300	PFS-1250-600V-120 ⑥	~	

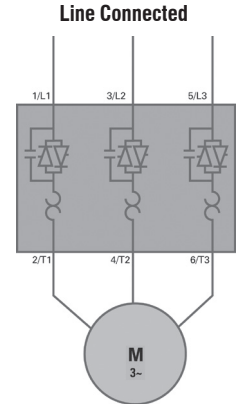

**D**  
PFS Softstarters

- ① Controllers rated 108 A and greater are not equipped with line and load terminal lugs. See page D49 for terminal lug kits.
- ② Motor FLA rating must fall within specified current range for unit to operate properly. Special consideration should be given when using a motor with a potentially high starting current (greater than ten times motor FLA) with the PF in the "Full Voltage" starting mode. Contact Sprecher+Schuh technical support for further guidance.

- ③ Hp ratings at motor terminal voltages for 200, 230, 460, and 575 line volts, respectively.
- ④ Separate 120V or 240V single phase is required for PF fan operation.
- ⑤ See page D48 if ordering factory installed PFB Pump Control or PFD Smart Motor Bake Control Modules, or other options.
- ⑥ 110/120V control power only. For 230V control power only, change catalog number suffix "-120" to "-230".

### Open Type Controller - Delta Connected ①②⑦

Rated Voltage [V AC]	Motor Current (Amps) ④	Max. kW 50 Hz	Max. Hp 60 Hz ⑤	100...240V AC 50/60Hz	24V AC/DC
				Control Voltage ⑥	Control Voltage ⑥
				Catalog Number	Catalog Number
200/208	1.7...8.7	~	2	PFS-0005-600V	PFS-0005-600V-024
	8.7...43	~	10	PFS-0025-600V	PFS-0025-600V-024
	14.9...74	~	20	PFS-0043-600V	PFS-0043-600V-024
	20.8...104	~	30	PFS-0060-600V	PFS-0060-600V-024
	29.4...147	~	40	PFS-0085-600V	PFS-0085-600V-024
	47...187	~	60	PFS-0108-600V	PFS-0108-600V-024
	59...234	~	75	PFS-0135-600V	PFS-0135-600V-024
	116...348	~	100	PFS-0201-600V	PFS-0201-600V-024
	145...435	~	150	PFS-0251-600V	PFS-0251-600V-024
	183...549	~	200	PFS-0317-600V	PFS-0317-600V-024
	208...625	~	200	PFS-0361-600V	PFS-0361-600V-024
	277...831	~	300	PFS-0480-600V	PFS-0480-600V-024
	283...850	~	300	PFS-0625-600V-120 ⑥	~
	300...900	~	300	PFS-0780-600V-120 ⑥	~
400...1200	~	400	PFS-0970-600V-120 ⑥	~	
533...1600	~	500	PFS-1250-600V-120 ⑥	~	
230	1.7...8.7	2.2	2	PFS-0005-600V	PFS-0005-600V-024
	8.7...43	11	15	PFS-0025-600V	PFS-0025-600V-024
	14.9...74	22	25	PFS-0043-600V	PFS-0043-600V-024
	20.8...104	30	40	PFS-0060-600V	PFS-0060-600V-024
	29.4...147	45	50	PFS-0085-600V	PFS-0085-600V-024
	47...187	55	60	PFS-0108-600V	PFS-0108-600V-024
	59...234	75	75	PFS-0135-600V	PFS-0135-600V-024
	116...348	110	125	PFS-0201-600V	PFS-0201-600V-024
	145...435	132	150	PFS-0251-600V	PFS-0251-600V-024
	183...549	160	200	PFS-0317-600V	PFS-0317-600V-024
	208...625	200	250	PFS-0361-600V	PFS-0361-600V-024
	277...831	250	350	PFS-0480-600V	PFS-0480-600V-024
	283...850	250	350	PFS-0625-600V-120 ⑥	~
	300...900	250	350	PFS-0780-600V-120 ⑥	~
400...1200	400	400	PFS-0970-600V-120 ⑥	~	
533...1600	500	600	PFS-1250-600V-120 ⑥	~	

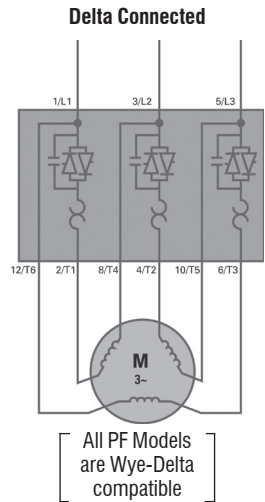

- ① Controllers rated 108 A and greater are not equipped with line and load terminal lugs. See page D49 for terminal lug kits.
- ② See page D48 if ordering factory installed PFB Pump Control or PFD Smart Motor Bake Control Modules, or other options.
- ③ Hp ratings at motor terminal voltages for 200, 230, 460, and 575 line volts, respectively.
- ④ Motor FLA rating must fall within specified current range for unit to operate properly. Special consideration should be given when using a motor with a potentially high starting current (greater than ten times motor FLA) with the PF in the "Full Voltage" starting mode. Contact Sprecher+Schuh technical support for further guidance.

- ⑤ Separate 120V or 240V single phase is required for PF fan operation.
- ⑥ 110/120V control power only. For 230V control power only, change catalog number suffix "-120" to "-230".
- ⑦ It is recommended that an isolation contactor be added to the circuit to provide galvanic isolation of the motor and final electromechanical removal of power.



**Open Type Controller - Delta Connected ①②⑦**

Rated Voltage [V AC]	Motor Current (Amps) ②	Max. kW 50 Hz	Max. Hp 60 Hz ③	100...240V AC 50/60Hz Control Voltage ⑤	24V AC/DC Control Voltage ⑤
				Catalog Number	Catalog Number
460	1.7...8.7	4	5	PFS-0005-600V	PFS-0005-600V-024
	8.7...43	22	30	PFS-0025-600V	PFS-0025-600V-024
	14.9...74	37	50	PFS-0043-600V	PFS-0043-600V-024
	20.8...104	55	75	PFS-0060-600V	PFS-0060-600V-024
	29.4...147	75	100	PFS-0085-600V	PFS-0085-600V-024
	47...187	90	150	PFS-0108-600V	PFS-0108-600V-024
	59...234	132	150	PFS-0135-600V	PFS-0135-600V-024
	116...348	160	250	PFS-0201-600V	PFS-0201-600V-024
	145...435	250	350	PFS-0251-600V	PFS-0251-600V-024
	183...549	315	450	PFS-0317-600V	PFS-0317-600V-024
	208...625	355	500	PFS-0361-600V	PFS-0361-600V-024
	277...831	450	700	PFS-0480-600V	PFS-0480-600V-024
	283...850	500	700	PFS-0625-600V-120 ⑥	~
	300...900	500	700	PFS-0780-600V-120 ⑥	~
400...1200	710	1000	PFS-0970-600V-120 ⑥	~	
530...1600	900	1400	PFS-1250-600V-120 ⑥	~	
500/575	1.7...8.7	5.5	7.5	PFS-0005-600V	PFS-0005-600V-024
	8.7...43	15	40	PFS-0025-600V	PFS-0025-600V-024
	14.9...74	45	60	PFS-0043-600V	PFS-0043-600V-024
	20.8...104	55	100	PFS-0060-600V	PFS-0060-600V-024
	29.4...147	90	150	PFS-0085-600V	PFS-0085-600V-024
	47...187	132	150	PFS-0108-600V	PFS-0108-600V-024
	59...234	160	200	PFS-0135-600V	PFS-0135-600V-024
	116...348	250	350	PFS-0201-600V	PFS-0201-600V-024
	145...435	315	400	PFS-0251-600V	PFS-0251-600V-024
	183...549	400	500	PFS-0317-600V	PFS-0317-600V-024
	208...625	450	600	PFS-0361-600V	PFS-0361-600V-024
	277...831	560	900	PFS-0480-600V	PFS-0480-600V-024
	283...850	560	900	PFS-0625-600V-120 ⑥	~
	300...900	630	900	PFS-0780-600V-120 ⑥	~
400...1200	800	1300	PFS-0970-600V-120 ⑥	~	
533...1600	1100	1600	PFS-1250-600V-120 ⑥	~	

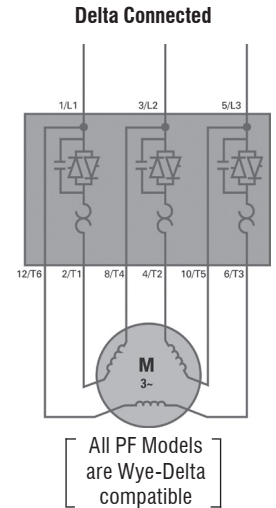

**D**  
PFS Softstarters

- ① Controllers rated 108 A and greater are not equipped with line and load terminal lugs. See page D49 for terminal lug kits.
- ② See page D48 if ordering factory installed PFB Pump Control or PFD Smart Motor Bake Control Modules, or other options.
- ③ Hp ratings at motor terminal voltages for 200, 230, 460, and 575 line volts, respectively.
- ④ Motor FLA rating must fall within specified current range for unit to operate properly. Special consideration should be given when using a motor with a potentially high starting current (greater than ten times motor FLA) with the PF in the "Full Voltage" starting mode. Contact Sprecher+Schuh technical support for further guidance.

- ⑤ Separate 120V or 240V single phase is required for PF fan operation.
- ⑥ 110/120V control power only. For 230V control power only, change catalog number suffix "-120" to "-230". Price remains the same.
- ⑦ It is recommended that an isolation contactor be added to the circuit to provide galvanic isolation of the motor and final electromechanical removal of power.

**Enclosed Non-Combination Starters - Line Connected ②③④**

Rated Voltage [V AC]	Motor Current (Amps) ①	kW 50 Hz	Hp 60 Hz	Type 12 [Type 3R ⑤] Industrial Dust-tight		Type 4 Watertight	
				Catalog Number	Price	Catalog Number	Price
200/208	1...5	—	1	PFS-0005-NHDD		PFS-0005-NHDW	
	5...25	—	5	PFS-0025-NHDD		PFS-0025-NHDW	
	8.6...43	—	10	PFS-0043-NHDD		PFS-0043-NHDW	
	12...60	—	15	PFS-0060-NHDD		PFS-0060-NHDW	
	17...85	—	25	PFS-0085-NHDD		PFS-0085-NHDW	
	27...108	—	30	PFS-0108-NHDD		PFS-0108-NHDW	
	34...135	—	40	PFS-0135-NHDD		PFS-0135-NHDW	
	67...201	—	60	PFS-0201-NHDD		PFS-0201-NHDW	
	84...251	—	75	PFS-0251-NHDD		PFS-0251-NHDW	
	106...317	—	100	PFS-0317-NHDD		PFS-0317-NHDW	
	120...361	—	125	PFS-0361-NHDD		PFS-0361-NHDW	
	160...480	—	150	PFS-0480-NHDD		PFS-0480-NHDW	
	208...625	—	200	PFS-0625-NHDD		PFS-0625-NHDW	
	260...780	—	250	PFS-0780-NHDD		PFS-0780-NHDW	
323...970	—	350	PFS-0970-NHDD		PFS-0970-NHDW		
416...1250	—	400	PFS-1250-NHDD		PFS-1250-NHDW		
230	1...5	1.1	1	PFS-0005-NADD		PFS-0005-NADW	
	5...25	5.5	7.5	PFS-0025-NADD		PFS-0025-NADW	
	8.6...43	11	15	PFS-0043-NADD		PFS-0043-NADW	
	12...60	15	20	PFS-0060-NADD		PFS-0060-NADW	
	17...85	22	30	PFS-0085-NADD		PFS-0085-NADW	
	27...108	30	40	PFS-0108-NADD		PFS-0108-NADW	
	34...135	37	50	PFS-0135-NADD		PFS-0135-NADW	
	67...201	55	75	PFS-0201-NADD		PFS-0201-NADW	
	84...251	75	100	PFS-0251-NADD		PFS-0251-NADW	
	106...317	90	125	PFS-0317-NADD		PFS-0317-NADW	
	120...361	110	150	PFS-0361-NADD		PFS-0361-NADW	
	160...480	132	200	PFS-0480-NADD		PFS-0480-NADW	
	208...625	200	250	PFS-0625-NADD		PFS-0625-NADW	
	260...780	250	300	PFS-0780-NADD		PFS-0780-NADW	
323...970	315	400	PFS-0970-NADD		PFS-0970-NADW		
416...1250	400	500	PFS-1250-NADD		PFS-1250-NADW		

**Non-Combination PF Softstarters include:**

- A 120V control power transformer with fused primary and secondary
- PF built-in electronic motor overload protection
- PF built-in SCR bypass/run contactor
- Available in UL Type 12 or 4 Enclosures
- Terminal blocks for remote control devices

**D** PFS Softstarters

① Motor FLA rating must fall within specified current range for unit to operate properly. Special consideration should be given when using a motor with a potentially high starting current (greater than ten times motor FLA) with the PF in the "Full Voltage" starting mode. Contact Sprecher+Schuh technical support for further guidance.

② Line and load termination are provided as standard.

③ See page D48 if ordering factory installed PFB Pump Control or PFD Smart Motor Bake Control Modules, or other options.

④ Other UL type enclosures available. Ask your Sprecher + Schuh representative.

⑤ For outdoor applications, replace "D" in catalog number with an "R". All enclosures are Type-12 with a Drip Shield. Example: PFS-0085-NHDD becomes PFS-0085-NHDR.

**Enclosed Non-Combination Starters - Line Connected ②③④**

Rated Voltage [V AC]	Motor Current (Amps) ①	kW 50 Hz	Hp 60 Hz	Type 12 [Type 3R ⑤] Industrial Dust-tight		Type 4 Watertight	
				Catalog Number	Price	Catalog Number	Price
460 ⑥	1...5	2.2	3	PFS-0005-NBDD		PFS-0005-NBDW	
	5...25	11	15	PFS-0025-NBDD		PFS-0025-NBDW	
	8.6...43	22	30	PFS-0043-NBDD		PFS-0043-NBDW	
	12...60	30	40	PFS-0060-NBDD		PFS-0060-NBDW	
	17...85	45	60	PFS-0085-NBDD		PFS-0085-NBDW	
	27...108	55	75	PFS-0108-NBDD		PFS-0108-NBDW	
	34...135	75	100	PFS-0135-NBDD		PFS-0135-NBDW	
	67...201	110	150	PFS-0201-NBDD		PFS-0201-NBDW	
	84...251	132	200	PFS-0251-NBDD		PFS-0251-NBDW	
	106...317	160	250	PFS-0317-NBDD		PFS-0317-NBDW	
	120...361	200	300	PFS-0361-NBDD		PFS-0361-NBDW	
	160...480	250	400	PFS-0480-NBDD		PFS-0480-NBDW	
	208...625	355	500	PFS-0625-NBDD		PFS-0625-NBDW	
	260...780	450	600	PFS-0780-NBDD		PFS-0780-NBDW	
323...970	560	800	PFS-0970-NBDD		PFS-0970-NBDW		
416...1250	710	1000	PFS-1250-NBDD		PFS-1250-NBDW		
500/575	1...5	2.2	3	PFS-0005-NCDD		PFS-0005-NCDW	
	5...25	15	20	PFS-0025-NCDD		PFS-0025-NCDW	
	8.6...43	22	40	PFS-0043-NCDD		PFS-0043-NCDW	
	12...60	37	50	PFS-0060-NCDD		PFS-0060-NCDW	
	17...85	55	75	PFS-0085-NCDD		PFS-0085-NCDW	
	27...108	75	100	PFS-0108-NCDD		PFS-0108-NCDW	
	34...135	90	125	PFS-0135-NCDD		PFS-0135-NCDW	
	67...201	132	200	PFS-0201-NCDD		PFS-0201-NCDW	
	84...251	160	250	PFS-0251-NCDD		PFS-0251-NCDW	
	106...317	200	300	PFS-0317-NCDD		PFS-0317-NCDW	
	120...361	250	350	PFS-0361-NCDD		PFS-0361-NCDW	
	160...480	315	500	PFS-0480-NCDD		PFS-0480-NCDW	
	208...625	450	600	PFS-0625-NCDD		PFS-0625-NCDW	
	260...780	560	800	PFS-0780-NCDD		PFS-0780-NCDW	
323...970	710	1000	PFS-0970-NCDD		PFS-0970-NCDW		
416...1250	900	1300	PFS-1250-NCDD		PFS-1250-NCDW		

**Non-Combination PF Softstarters include:**

- A 120V control power transformer with fused primary and secondary
- PF built-in electronic motor overload protection
- PF built-in SCR bypass/run contactor
- Available in UL Type 12 or 4 Enclosures
- Terminal blocks for remote control devices

**D**  
*PFS Softstarters*

- ① Motor FLA rating must fall within specified current range for unit to operate properly. Special consideration should be given when using a motor with a potentially high starting current (greater than ten times motor FLA) with the PF in the "Full Voltage" starting mode. Contact Sprecher+Schuh technical support for further guidance.
- ② Line and load termination are provided as standard.
- ③ See page D48 if ordering factory installed PFB Pump Control or PFD Smart Motor Bake Control Modules, or other options.
- ④ Other UL type enclosures available. Ask your Sprecher + Schuh representative.

- ⑤ For 380V applications choose softstarter based on FLA, then change the NB code in the catalog number to NG. For example PFS-0085-NBDD becomes PFS-0085-NGDD, which covers 25 HP @ 380V FLA 37. Price remains the same.
- ⑥ For outdoor applications, replace "D" in catalog number with an "R". All enclosures are Type-12 with a Drip Shield. Example: PFS-0085-NBDD becomes PFS-0085-NBDR. Price and dimensions remain the same.

**Enclosed Combination Circuit Breaker - Line Connected ①②④**

Rated Voltage [V AC]	kW 50 Hz	Hp 60 Hz	Controller Current Rating ③	Type 12 [Type 3R ④] Industrial Dusttight Catalog Number	Type 4 Watertight Catalog Number
200	—	0.5	5 A	PFS-0005-BHD33D	PFS-0005-BHD33W
	—	0.75	5 A	PFS-0005-BHD34D	PFS-0005-BHD34W
	—	1	5 A	PFS-0005-BHD35D	PFS-0005-BHD35W
	—	1.5	25 A	PFS-0025-BHD36D	PFS-0025-BHD36W
	—	2	25 A	PFS-0025-BHD37D	PFS-0025-BHD37W
	—	3	25 A	PFS-0025-BHD38D	PFS-0025-BHD38W
	—	5	25 A	PFS-0025-BHD39D	PFS-0025-BHD39W
	—	5	25 A	PFS-0025-BHD40D	PFS-0025-BHD40W
	—	10	43 A	PFS-0043-BHD41D	PFS-0043-BHD41W
	—	15	60 A	PFS-0060-BHD42D	PFS-0060-BHD42W
	—	20	85 A	PFS-0085-BHD43D	PFS-0085-BHD43W
	—	25	85 A	PFS-0085-BHD44D	PFS-0085-BHD44W
	—	30	108 A	PFS-0108-BHD45D	PFS-0108-BHD45W
	—	40	135 A	PFS-0135-BHD46D	PFS-0135-BHD46W
	—	50	201 A	PFS-0201-BHD47D	PFS-0201-BHD47W
	—	60	201 A	PFS-0201-BHD48D	PFS-0201-BHD48W
	—	75	251 A	PFS-0251-BHD49D	PFS-0251-BHD49W
	—	100	317 A	PFS-0317-BHD50D	PFS-0317-BHD50W
—	125	361 A	PFS-0361-BHD51D	PFS-0361-BHD51W	
—	150	480 A	PFS-0480-BHD52D	PFS-0480-BHD52W	
—	200	625 A	PFS-0625-BHD54D	PFS-0625-BHD54W	
—	250	780 A	PFS-0780-BHD56D	PFS-0780-BHD56W	
230	0.37	0.5	5 A	PFS-0005-BAD33D	PFS-0005-BAD33W
	0.55	0.75	5 A	PFS-0005-BAD34D	PFS-0005-BAD34W
	0.75	1	5 A	PFS-0005-BAD35D	PFS-0005-BAD35W
	1.1	1.5	25 A	PFS-0025-BAD36D	PFS-0025-BAD36W
	1.5	2	25 A	PFS-0025-BAD37D	PFS-0025-BAD37W
	2.2	3	25 A	PFS-0025-BAD38D	PFS-0025-BAD38W
	3.7	5	25 A	PFS-0025-BAD39D	PFS-0025-BAD39W
	5.5	7.5	25 A	PFS-0025-BAD40D	PFS-0025-BAD40W
	7.5	10	43 A	PFS-0043-BAD41D	PFS-0043-BAD41W
	11	15	43 A	PFS-0043-BAD42D	PFS-0043-BAD42W
	15	20	60 A	PFS-0060-BAD43D	PFS-0060-BAD43W
	18.5	25	85 A	PFS-0085-BAD44D	PFS-0085-BAD44W
	22	30	85 A	PFS-0085-BAD45D	PFS-0085-BAD45W
	30	40	108 A	PFS-0108-BAD46D	PFS-0108-BAD46W
	37	50	135 A	PFS-0135-BAD47D	PFS-0135-BAD47W
	45	60	201 A	PFS-0201-BAD48D	PFS-0201-BAD48W
	55	75	201 A	PFS-0201-BAD49D	PFS-0201-BAD49W
	75	100	251 A	PFS-0251-BAD50D	PFS-0251-BAD50W
	90	125	317 A	PFS-0317-BAD51D	PFS-0317-BAD51W
	110	150	361 A	PFS-0361-BAD52D	PFS-0361-BAD52W
132	200	480 A	PFS-0480-BAD54D	PFS-0480-BAD54W	
185	250	625 A	PFS-0625-BAD56D	PFS-0625-BAD56W	
220	300	780 A	PFS-0780-BAD57D	PFS-0780-BAD57W	

**Combination Circuit Breaker PF Softstarters include:**

- A thermal magnetic circuit breaker with external operating handle
- A 120V control power transformer with fused primary and secondary
- PF built-in electronic motor overload protection
- PF built-in SCR bypass/run contactor
- Available in UL Type 12 or 4 Enclosures
- Terminal blocks for remote control devices

**D**  
PFS Softstarters

① Other UL Type enclosures available. Contact your Sprecher + Schuh representative.  
 ② See page D48 if ordering factory installed PFB Pump Control or PFD Smart Motor Bake Control Modules, or other options.  
 ③ The nominal current rating for the combination package may differ from the controller, based on the horsepower. Consult your Sprecher + Schuh representative.  
 ④ See page D57 for circuit breaker ratings.  
 ⑤ For outdoor applications, replace "D" in catalog number with an "R". All enclosures are Type-12 with a Drip Shield. Example: PFS-0085-BHD43D becomes PFS-0085-BHD43R.

**Enclosed Combination Circuit Breaker - Line Connected ①②④**

Rated Voltage [V AC]	kW 50 Hz	Hp 60 Hz	Controller Current Rating ⑤	Type 12 [Type 3R ⑥] Industrial Dusttight Catalog Number	Type 4 Watertight Catalog Number
460 ⑤	0.37	0.5	5 A	PFS-0005-BBD33D	PFS-0005-BBD33W
	0.55	0.75	5 A	PFS-0005-BBD34D	PFS-0005-BBD34W
	0.75	1	5 A	PFS-0005-BBD35D	PFS-0005-BBD35W
	1.1	1.5	5 A	PFS-0005-BBD36D	PFS-0005-BBD36W
	1.5	2	5 A	PFS-0005-BBD37D	PFS-0005-BBD37W
	2.2	3	5 A	PFS-0005-BBD38D	PFS-0005-BBD38W
	3.7	5	25 A	PFS-0025-BBD39D	PFS-0025-BBD39W
	5.5	7.5	25 A	PFS-0025-BBD40D	PFS-0025-BBD40W
	7.5	10	25 A	PFS-0025-BBD41D	PFS-0025-BBD41W
	11	15	25 A	PFS-0025-BBD42D	PFS-0025-BBD42W
	15	20	43 A	PFS-0043-BBD43D	PFS-0043-BBD43W
	18.5	25	43 A	PFS-0043-BBD44D	PFS-0043-BBD44W
	22	30	43 A	PFS-0043-BBD45D	PFS-0043-BBD45W
	30	40	60 A	PFS-0060-BBD46D	PFS-0060-BBD46W
	37	50	85 A	PFS-0085-BBD47D	PFS-0085-BBD47W
	45	60	85 A	PFS-0085-BBD48D	PFS-0085-BBD48W
	55	75	108 A	PFS-0108-BBD49D	PFS-0108-BBD49W
	75	100	135 A	PFS-0135-BBD50D	PFS-0135-BBD50W
	90	125	201 A	PFS-0201-BBD51D	PFS-0201-BBD51W
	110	150	201 A	PFS-0201-BBD52D	PFS-0201-BBD52W
132	200	251 A	PFS-0251-BBD54D	PFS-0251-BBD54W	
160	250	317 A	PFS-0317-BBD56D	PFS-0317-BBD56W	
200	300	361 A	PFS-0361-BBD57D	PFS-0361-BBD57W	
250	350	480 A	PFS-0480-BBD58D	PFS-0480-BBD58W	
250	400	480 A	PFS-0480-BBD59D	PFS-0480-BBD59W	
355	500	625 A	PFS-0625-BBD61D	PFS-0625-BBD61W	
450	600	780 A	PFS-0780-BBD62D	PFS-0780-BBD62W	
575	0.37	0.75	5 A	PFS-0005-BCD34D	PFS-0005-BCD34W
	0.55	1	5 A	PFS-0005-BCD35D	PFS-0005-BCD35W
	0.75	1.5	5 A	PFS-0005-BCD36D	PFS-0005-BCD36W
	1.1	2	5 A	PFS-0005-BCD37D	PFS-0005-BCD37W
	2.2	3	5 A	PFS-0005-BCD38D	PFS-0005-BCD38W
	3.7	5	25 A	PFS-0025-BCD39D	PFS-0025-BCD39W
	5.5	7.5	25 A	PFS-0025-BCD40D	PFS-0025-BCD40W
	7.5	10	25 A	PFS-0025-BCD41D	PFS-0025-BCD41W
	11	15	25 A	PFS-0025-BCD42D	PFS-0025-BCD42W
	15	20	43 A	PFS-0043-BCD43D	PFS-0043-BCD43W
	18.5	25	43 A	PFS-0043-BCD44D	PFS-0043-BCD44W
	22	30	43 A	PFS-0043-BCD45D	PFS-0043-BCD45W
	22	40	43 A	PFS-0043-BCD46D	PFS-0043-BCD46W
	37	50	60 A	PFS-0060-BCD47D	PFS-0060-BCD47W
	45	60	85 A	PFS-0085-BCD48D	PFS-0085-BCD48W
	55	75	85 A	PFS-0085-BCD49D	PFS-0085-BCD49W
	75	100	108 A	PFS-0108-BCD50D	PFS-0108-BCD50W
	90	125	135 A	PFS-0135-BCD51D	PFS-0135-BCD51W
	110	150	201 A	PFS-0201-BCD52D	PFS-0201-BCD52W
	132	200	201 A	PFS-0201-BCD54D	PFS-0201-BCD54W
160	250	251 A	PFS-0251-BCD56D	PFS-0251-BCD56W	
200	300	317 A	PFS-0317-BCD57D	PFS-0317-BCD57W	
250	350	361 A	PFS-0361-BCD58D	PFS-0361-BCD58W	
295	400	480 A	PFS-0480-BCD59D	PFS-0480-BCD59W	
315	450	480 A	PFS-0480-BCD60D	PFS-0480-BCD60W	
315	500	480 A	PFS-0480-BCD61D	PFS-0480-BCD61W	
450	600	625 A	PFS-0625-BCD62D	PFS-0625-BCD62W	
560	800	780 A	PFS-0780-BCD65D	PFS-0780-BCD65W	

**Combination Circuit Breaker PF Softstarters include:**

- A thermal magnetic circuit breaker with external operating handle
- A 120V control power transformer with fused primary and secondary
- PF built-in electronic motor overload protection
- PF built-in SCR bypass/run contactor
- Available in UL Type 12 or 4 Enclosures
- Terminal blocks for remote control devices

- ① Other UL Type enclosures available. Contact your Sprecher + Schuh representative.
- ② See page D48 if ordering factory installed PFB Pump Control or PFD Smart Motor Bake Control Modules, or other options.
- ③ The nominal current rating for the combination package may differ from the controller, based on the horse power. Consult your Sprecher + Schuh representative.
- ④ See page D57 for circuit breaker ratings.
- ⑤ For 380V applications choose softstarter based on FLA, then change the BB code in the catalog number to BG. Example PFS-0085-BBD47D becomes PFS-0085-BGD47D, which covers 25 HP @ 380V FLA 37. Price remains the same.
- ⑥ For outdoor applications, replace "D" in catalog number with an "R". All enclosures are Type-12 with a Drip Shield. For example catalog number PFS-0085-BBD47D becomes PFS-0085-BBD47R.

**D**  
PFS Softstarters

**Enclosed Combination Fusible Starters - Line Connected ①②④**

Rated Voltage [V AC]	kW 50 Hz	Hp 60 Hz	Controller Current Rating ③	Type 12 [Type 3R ⑤] Industrial Dusttight	Type 4 Watertight	
				Catalog Number	Catalog Number	
200	—	0.5	5 A	PFS-0005-FHD33D	PFS-0005-FHD33W	
	—	0.75	5 A	PFS-0005-FHD34D	PFS-0005-FHD34W	
	—	1	5 A	PFS-0005-FHD35D	PFS-0005-FHD35W	
	—	1.5	25 A	PFS-0025-FHD36D	PFS-0025-FHD36W	
	—	2	25 A	PFS-0025-FHD37D	PFS-0025-FHD37W	
	—	3	25 A	PFS-0025-FHD38D	PFS-0025-FHD38W	
	—	5	25 A	PFS-0025-FHD39D	PFS-0025-FHD39W	
	—	7.5	25 A	PFS-0025-FHD40D	PFS-0025-FHD40W	
	—	10	43 A	PFS-0043-FHD41D	PFS-0043-FHD41W	
	—	15	60 A	PFS-0060-FHD42D	PFS-0060-FHD42W	
	—	20	85 A	PFS-0085-FHD43D	PFS-0085-FHD43W	
	—	25	85 A	PFS-0085-FHD44D	PFS-0085-FHD44W	
	—	30	108 A	PFS-0108-FHD45D	PFS-0108-FHD45W	
	—	40	135 A	PFS-0135-FHD46D	PFS-0135-FHD46W	
	—	50	201 A	PFS-0201-FHD47D	PFS-0201-FHD47W	
	—	60	201 A	PFS-0201-FHD48D	PFS-0201-FHD48W	
	230	0.37	0.5	5 A	PFS-0005-FAD33D	PFS-0005-FAD33W
		0.55	0.75	5 A	PFS-0005-FAD34D	PFS-0005-FAD34W
0.75		1	5 A	PFS-0005-FAD35D	PFS-0005-FAD35W	
1.1		1.5	25 A	PFS-0025-FAD36D	PFS-0025-FAD36W	
1.5		2	25 A	PFS-0025-FAD37D	PFS-0025-FAD37W	
2.2		3	25 A	PFS-0025-FAD38D	PFS-0025-FAD38W	
3.7		5	25 A	PFS-0025-FAD39D	PFS-0025-FAD39W	
5.5		7.5	25 A	PFS-0025-FAD40D	PFS-0025-FAD40W	
7.5		10	43 A	PFS-0043-FAD41D	PFS-0043-FAD41W	
11		15	43 A	PFS-0043-FAD42D	PFS-0043-FAD42W	
15		20	60 A	PFS-0060-FAD43D	PFS-0060-FAD43W	
18.5		25	85 A	PFS-0085-FAD44D	PFS-0085-FAD44W	
22		30	85 A	PFS-0085-FAD45D	PFS-0085-FAD45W	
30		40	108 A	PFS-0108-FAD46D	PFS-0108-FAD46W	
37		50	135 A	PFS-0135-FAD47D	PFS-0135-FAD47W	
45		60	201 A	PFS-0201-FAD48D	PFS-0201-FAD48W	
55		75	201 A	PFS-0201-FAD49D	PFS-0201-FAD49W	
75		100	251 A	PFS-0251-FAD50D	PFS-0251-FAD50W	
90		125	317 A	PFS-0317-FAD51D	PFS-0317-FAD51W	
110		150	361 A	PFS-0361-FAD52D	PFS-0361-FAD52W	
132	200	480 A	PFS-0480-FAD54D	PFS-0480-FAD54W		
185	250	625 A	PFS-0625-FAD56D	PFS-0625-FAD56W		
220	300	780 A	PFS-0780-FAD57D	PFS-0780-FAD57W		

**Combination Fusible PF Softstarters include:**

- A fused switch with external operating handle
- A 120V control power transformer with fused primary and secondary
- PF built-in electronic motor overload protection
- PF built-in SCR bypass/run contactor
- Available in UL Type 12 or 4 Enclosures
- Terminal blocks for remote control devices

**D**  
PFS Softstarters

- ① Other UL Type enclosures available. Contact your Sprecher + Schuh representative.
- ② See page D48 if ordering factory installed PFB Pump Control or PFD Smart Motor Bake Control Modules, or other options.
- ③ The nominal current rating for the combination package may differ from the controller, based on the horse power. Consult your Sprecher + Schuh representative.
- ④ Fuse clips accept J-type fuses. Power fuses are not supplied. See page D57 for Fusible Disconnect amp ratings.
- ⑤ For outdoor applications, replace "D" in catalog number with an "R". All enclosures are Type-12 with a Drip Shield. For example: PFS-0085-FHD43D becomes PFS-0085-FHD43R.



### Enclosed Combination Fusible Starters - Line Connected ①②④

Rated Voltage [V AC]	kW 50 Hz	Hp 60 Hz	Controller Current Rating ⑤	Type 12 [Type 3R ⑥] Industrial Dusttight	Type 4 Watertight
				Catalog Number	Catalog Number
460 ⑥	0.37	0.5	5 A	PFS-0005-FBD33D	PFS-0005-FBD33W
	0.55	0.75	5 A	PFS-0005-FBD34D	PFS-0005-FBD34W
	0.75	1	5 A	PFS-0005-FBD35D	PFS-0005-FBD35W
	1.1	1.5	5 A	PFS-0005-FBD36D	PFS-0005-FBD36W
	1.5	2	5 A	PFS-0005-FBD37D	PFS-0005-FBD37W
	2.2	3	5 A	PFS-0005-FBD38D	PFS-0005-FBD38W
	3.7	5	25 A	PFS-0025-FBD39D	PFS-0025-FBD39W
	5.5	7.5	25 A	PFS-0025-FBD40D	PFS-0025-FBD40W
	7.5	10	25 A	PFS-0025-FBD41D	PFS-0025-FBD41W
	11	15	25 A	PFS-0025-FBD42D	PFS-0025-FBD42W
	15	20	43 A	PFS-0043-FBD43D	PFS-0043-FBD43W
	18.5	25	43 A	PFS-0043-FBD44D	PFS-0043-FBD44W
	22	30	43 A	PFS-0043-FBD45D	PFS-0043-FBD45W
	30	40	60 A	PFS-0060-FBD46D	PFS-0060-FBD46W
	37	50	85 A	PFS-0085-FBD47D	PFS-0085-FBD47W
	45	60	85 A	PFS-0085-FBD48D	PFS-0085-FBD48W
	55	75	108 A	PFS-0108-FBD49D	PFS-0108-FBD49W
	75	100	135 A	PFS-0135-FBD50D	PFS-0135-FBD50W
	90	125	201 A	PFS-0201-FBD51D	PFS-0201-FBD51W
	110	150	201 A	PFS-0201-FBD52D	PFS-0201-FBD52W
132	200	251 A	PFS-0251-FBD54D	PFS-0251-FBD54W	
160	250	317 A	PFS-0317-FBD56D	PFS-0317-FBD56W	
200	300	361 A	PFS-0361-FBD57D	PFS-0361-FBD57W	
250	350	480 A	PFS-0480-FBD58D	PFS-0480-FBD58W	
250	400	480 A	PFS-0480-FBD59D	PFS-0480-FBD59W	
355	500	625 A	PFS-0625-FBD61D	PFS-0625-FBD61W	
450	600	780 A	PFS-0780-FBD62D	PFS-0780-FBD62W	
575	0.37	0.75	5 A	PFS-0005-FCD34D	PFS-0005-FCD34W
	0.55	1	5 A	PFS-0005-FCD35D	PFS-0005-FCD35W
	0.75	1.5	5 A	PFS-0005-FCD36D	PFS-0005-FCD36W
	1.1	2	5 A	PFS-0005-FCD37D	PFS-0005-FCD37W
	2.2	3	5 A	PFS-0005-FCD38D	PFS-0005-FCD38W
	3.7	5	25 A	PFS-0025-FCD39D	PFS-0025-FCD39W
	5.5	7.5	25 A	PFS-0025-FCD40D	PFS-0025-FCD40W
	7.5	10	25 A	PFS-0025-FCD41D	PFS-0025-FCD41W
	11	15	25 A	PFS-0025-FCD42D	PFS-0025-FCD42W
	15	20	43 A	PFS-0043-FCD43D	PFS-0043-FCD43W
	18.5	25	43 A	PFS-0043-FCD44D	PFS-0043-FCD44W
	22	30	43 A	PFS-0043-FCD45D	PFS-0043-FCD45W
	22	40	43 A	PFS-0043-FCD46D	PFS-0043-FCD46W
	37	50	60 A	PFS-0060-FCD47D	PFS-0060-FCD47W
	45	60	85 A	PFS-0085-FCD48D	PFS-0085-FCD48W
	55	75	85 A	PFS-0085-FCD49D	PFS-0085-FCD49W
	75	100	108 A	PFS-0108-FCD50D	PFS-0108-FCD50W
	90	125	135 A	PFS-0135-FCD51D	PFS-0135-FCD51W
	110	150	201 A	PFS-0201-FCD52D	PFS-0201-FCD52W
	132	200	201 A	PFS-0201-FCD54D	PFS-0201-FCD54W
160	250	251 A	PFS-0251-FCD56D	PFS-0251-FCD56W	
200	300	317 A	PFS-0317-FCD57D	PFS-0317-FCD57W	
250	350	361 A	PFS-0361-FCD58D	PFS-0361-FCD58W	
295	400	480 A	PFS-0480-FCD59D	PFS-0480-FCD59W	
315	450	480 A	PFS-0480-FCD60D	PFS-0480-FCD60W	
315	500	480 A	PFS-0480-FCD61D	PFS-0480-FCD61W	
450	600	625 A	PFS-0625-FCD62D	PFS-0625-FCD62W	
560	800	780 A	PFS-0780-FCD65D	PFS-0780-FCD65W	

### Combination Fusible PF Softstarters include:

- A fused switch with external operating handle
- A 120V control power transformer with fused primary and secondary
- PF built-in electronic motor overload protection
- PF built-in SCR bypass/run contactor
- Available in UL Type 12 or 4 Enclosures
- Terminal blocks for remote control devices

- ① Other UL Type enclosures available. Contact your Sprecher + Schuh representative for pricing.
- ② See page D48 if ordering factory installed PFB Pump Control or PFD Smart Motor Bake Control Modules, or other options.
- ③ The nominal current rating for the combination package may differ from the controller, based on the horsepower. Consult your Sprecher + Schuh representative.
- ④ Fuse clips accept J-type fuses (Class L fuses for some PF-480 applications; see page D57 for details). Power fuses are not supplied.
- ⑤ For 380V applications choose softstarter based on FLA, then change the FB code in the catalog number to FG. Example PFS-0085-FBD47D becomes PFS-0085-FGD47D, which covers 25 HP @ 380V FLA 37.
- ⑥ For outdoor applications, replace "D" in catalog number with an "R". All enclosures are Type-12 with a Drip Shield. Example: PFS-0085-FBD47D becomes PFS-0085-FBD47R.

D  
PFS Softstarters

**Options - Factory Modifications**

**D**  
PFS Softstarters

Description	Catalog Number
<b>Pump Control ①</b> Provides smooth motor acceleration and deceleration, reducing surges caused by the starting and stopping of centrifugal pumps. Starting time is adjustable from 0...30 seconds and stopping time is adjustable from 0...120 seconds For 5A unit For 25A unit For 43A unit For 60A unit For 85A unit For 108A unit For 135A unit For 201A unit For 251A unit For 317A unit For 361A unit For 480A unit For 625A unit For 780A unit For 970A unit For 1250A unit	Change "PFS" to "PFB"
<b>Braking Control ①②</b> Provides Smart Motor Brake, Accu-Stop, and Slow Speed with Braking For 5A unit For 25A unit For 43A unit For 60A unit For 85A unit For 108A unit For 135A unit For 201A unit For 251A unit For 317A unit For 361A unit For 480A unit For 625A unit For 780A unit For 970A unit For 1250A unit	Change "PFS" to "PFD"
<b>Protective Module</b> Protects power components from transient voltage spikes and transient voltage spikes and shunts noise energy 600V Line Side Protective Module 600V Load Side Protective Module 600V Both Line and Load Side Protective Modules	Add suffix - " <b>-8L</b> " Add suffix - " <b>-8M</b> " Add suffix - " <b>-8B</b> "

Description	Catalog Number
<b>Pushbuttons (2)</b> START and STOP pushbuttons for enclosed softstarters	Add suffix " <b>-3</b> "
<b>Selector Switch</b> Two or three position selector switch for enclosed softstarters "ON-OFF" "HAND-OFF-AUTO"	Add suffix " <b>-6</b> " Add suffix " <b>-7</b> "
<b>Pilot Light ③</b> Red pilot light with "RUN" inscription for enclosed softstarters	Add suffix " <b>-1</b> "
<b>Voltmeter (Panelboard)</b> Measures all three phases. Includes switch.	Add suffix " <b>-VM3</b> "
<b>Ammeter (Panelboard)</b> For monitoring all three phases. Includes switch.	Add suffix " <b>-AM3</b> "
<b>Elapsed Time Meter</b> Measures elapsed motor running time	Add suffix " <b>-ETM</b> "

- ① Only one option may be added to the standard unit. See detailed descriptions of options starting on page D34.
- ② Not intended to be used as an emergency stop. Refer to applicable standards for emergency stop requirements.
- ③ When adding Pilot Lights plus other cover controls, add the Pilot Light first. For example; to add a Start-Stop Pushbutton and a Pilot Light, add **-13** at the end of the part number, not -31.

### Options - Field Modifications

#### Protective Modules ❶

 <p>PFP-0085-600V</p>	Current Rating	Description	Catalog Number
	5...85	600V Protective Module <ul style="list-style-type: none"> <li>• PF (3 Lead) Line Connected Applications: Protective modules may be installed on the line and/or load side</li> <li>• PF (6 Lead) Delta Connected Applications: Protective modules must be installed on the line side only.</li> <li>• Clamping voltage range 705V...1750V, energy rating 290 joules</li> </ul>	<b>PFP-0085-600V</b>
108...480	<b>PFP-0480-600V</b>		

#### Terminal Lug Kits (108...1250 A) ❷

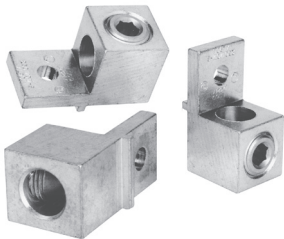
	Current Rating (A)	Conductor Size	Total No. of Line Controller Terminal Lugs Possible Each Side		Pkg. Qty.	Catalog Number
			Line Side	Load Side		
	108...135	#6...250 MCM AWG	3	3	3	<b>PNX-1120</b>
	201...251	16 mm <sup>2</sup> ...120mm <sup>2</sup>	6	6		<b>PNX-1240</b>
	317...480	#4...500 MCM AWG 25 mm <sup>2</sup> ...240MM <sup>2</sup>	6	6		<b>CA6-L630</b>
	625...780	2/0...500 MCM AWG	6	6		<b>CA6-L860</b>
	970	4/0...500 MCM AWG	3	3		<b>CA6-L630</b>
	1250	2/0...500 MCM AWG	3	3		<b>CA6-L630</b>
4/0...500 MCM AWG		3	3	<b>CA6-L860</b>		

#### IEC Terminal Covers ❸ ❹

	Description	Pkg. Qty.	Catalog Number
	IEC line or load terminal covers for 108...135A devices. Dead front protection	1	<b>PFT-0135</b>
	IEC line or load terminal covers for 201...251A devices. Dead front protection		<b>PFT-0251</b>
IEC line or load terminal covers for 317...480A devices. Dead front protection.	<b>PFT-0480</b>		

- ❶ The same protective module mounts on the line or load side of the PF Softstarter. For applications requiring both line and load side protection, two protective modules must be ordered.
- ❷ Line and Load terminals are provided as standard on enclosed PF Softstarters.
- ❸ PF 5...85A units have box lugs as standard. No additional lugs are required. The 1250 A device requires (1) CA6-L630 and (1) CA6-L860 per connection. When a multi-conductor lug is required, refer to the PF User Manual for appropriate lug catalog number.
- ❹ PFx-108...480 units include one terminal guard as standard.

### Control Modules

Description	PF Rating	For units rated 200...600V AC			
		100...240V AC Catalog Number	Qty	24V AC/DC Catalog Number	Qty
Standard	All	PFS	1	PFS-024	1
Pump	All	PFB	1	PFB-024	1
Braking	5...85 A	PFD-0085	1	PFD-0085-024	1
	108...251 A	PFD-0251	1	PFD-0251-024	1
	317...480 A	PFD-0480	1	PFD-0480-024	1
	625...780 A	PFD-0780	1	~	~
	970...1250 A	PFD-1250	1	~	~

### Power Poles

PF Rating	Series	Line Voltage 200...600V Catalog Number ①	Qty
5 A	B	PFL-0005-600V ②	1
25 A	B	PFL-0025-600V ②	1
43 A	B	PFL-0043-600V ②	1
60 A	B	PFL-0060-600V ②	1
85 A	B	PFL-0085-600V ②	1
108 A	B	PFL-0108-600V ②	1
135 A	B	PFL-0135-600V ②	1
201 A	B	PFL-0201-600V ②	1
251 A	B	PFL-0251-600V ②	1
317 A	B	PFL-0317-600V ②	1
361 A	B	PFL-0361-600V ②	1
480 A	B	PFL-0480-600V ②	1
625 A	B	PFL-0625-600V ②	1
780 A	B	PFL-0780-600V ②	1
970 A	B	PFL-0970-600V ②	1
1250 A	B	PFL-1250-600V ②	1

Each power pole contains two SCR's and one bypass contactor power pole. The PF requires three power poles. For example: the replacement power pole for a PFS-0108-600V series B is PFL-0108-600V

### Internal Heatsink Fans

PF Rating	Series	Catalog Number	Qty
5...85 A	B	PFV-0085	1
108...135 A	B		
201...251 A	B	PFV-0251	1
317...480 A	B	PFV-0480	1
625...1250 A	B	PFV-1250-120	1
625...1250 A	B	PFV-1250-230	1

### By-Pass Contactor ④

PF Rating	Series	110/120V AC Catalog Number		Qty	230/240V AC Catalog Number		Qty
625...780 A	B	CA6-180-EI-11-120	See page A122	1	CA6-180-EI-11-220W	See page A122	1
970...1250 A	B	CA6-420-EI-11-120		1	CA6-420-EI-11-220W		1

- ① One piece provided per part number.
- ② Part number contains three power poles.
- ③ Part number contains one power pole.
- ④ See special installation instructions included in package.

**Standard Features**

Installation	Power Wiring	Standard squirrel-cage induction motor or a Wye-Delta, six-lead motor.
	Control Wiring	2- and 3-wire control for a wide variety of applications.
Setup	Keypad	Front keypad and backlit LCD display.
Starting and Stopping Modes		<ul style="list-style-type: none"> <li>• Soft Start</li> <li>• Current Limit Start</li> <li>• Dual Ramp</li> <li>• Full Voltage</li> <li>• Linear Speed Acceleration</li> <li>• Preset Slow Speed</li> <li>• Soft Stop</li> </ul>
Protection and Diagnostics		Power loss, line fault, voltage unbalance, excessive start/hour, phase reversal, undervoltage, overvoltage, controller temp, stall, jam, open gate, overload, underload.
Metering		Amps, Volts, kW, kWh, elapsed time, power factor, motor thermal capacity usage.
Alarm Contact		Overload, underload, undervoltage, overvoltage, unbalance, jam, stall, and ground fault
Status Indication		Stopped, starting, stopping, at speed, alarm, and fault.
Auxiliary Contacts		Four fully programmable contacts as normal/up-to-speed/external bypass/fault/alarm, (N.O./N.C.). On external bypass (N.O. only).

**Optional Features**

Pump Control		Helps reduce fluid surges in centrifugal pumping systems during starting and stopping period. Starting time is adjustable from 0...30 seconds. Stopping time is adjustable from 0...120 seconds.
Braking Control	Smart Motor Brake	Provides motor braking without additional equipment for applications that require the motor to stop quickly. Braking current is adjustable from 0...400% of the motor's full load current rating.
	Accu-Stop	Provides controlled position stopping. During stopping, braking torque is applied to the motor until it reaches preset slow speed (7% or 15% of rated speed) and holds the motor at this speed until a stop command is given. Braking torque is then applied until the motor reaches zero speed. Braking current is programmable from 0...450% of full load current.
	Slow Speed with Braking	Used on applications that require slow speed (in the forward direction) for positioning or alignment and also require braking control to stop.

**D**  
**PFS Softstarters**
**Technical Information**

Electrical Ratings		UL/CSA/NEMA		IEC	
Power Circuit	Rated Operation Voltage	200...600V AC (-15%, +10%)		200...500V	
	Rated Insulation Voltage	N/A		500V	
	Rated Impulse Voltage	N/A		6000V	
	Dielectric Withstand	2200V AC		2500V	
	Repetitive Peak Inverse Voltage Rating	1600V		1600V	
	Operating Frequency	50/60 Hz			
	Utilization Category	5...480 A	MG 1		AC-53B:3.0-50:1750
		625...1250 A	MG 1		AC-53B:3.0-50:3550
	Protection Against Electrical Shock	5...85 A	NA		IP20
		108...480 A			IP2X (with terminal covers)
625...1250 A		IP00 (open device)			
DV/DT Protection	RC Snubber Network				
Transient Protection	Metal Oxide Varistors: 220 Joules				
Control Circuit	Rated Operational Voltage	UL/CSA/NEMA		IEC	
		100...240V AC or 24V AC/DC (-15%, +10%)			
	Rated Insulation Voltage	110/120V AC and 230/240V AC		240V	
		N/A		3000V	
	Rated Impulse Voltage	N/A		2000V	
	Dielectric Withstand	1600V AC		2000V	
	Operating Frequency	50/60 Hz			
	Input on state voltage minimum (terminals 15-18)	85V AC, 19.2V DC / 20.4V AC			
	Input on state current (terminals 15-18)	20 mA @ 120V AC/40 mA @ 240V AC, 7.6 mA @ 24V AC/DC			
	Input off state voltage maximum (terminals 15-18)	50V AC, 10V DC / 12V AC			
Input off state current @ input off state voltage (terminals 15-18)	<10 mA AC, <3 mA DC				

#### Electrical Ratings

SCPD Performance 200...600V		Type 1 ④						
SCPD List ①	Device Rating	Max. Standard Available Fault	Max. Standard Fuse (A) ②	Max. Standard Available Fault	Max. Circuit Breaker (A)	Max. High Fault	Max. Fuse (A) ③	
Line Device Operational Current Rating (A)	5	5 kA	20	5 kA	20	70 kA	10	
	25	5 kA	100	5 kA	100	70 kA	50	
	43	10 kA	150	10 kA	150	70 kA	90	
	60	10 kA	225	10 kA	225	70 kA	125	
	85	10 kA	300	10 kA	300	70 kA	175	
	108	10 kA	400	10 kA	300	70 kA	200	
	135	10 kA	500	10 kA	400	70 kA	225	
	201	18 kA	600	18 kA	600	70 kA	350	
	251	18 kA	700	18 kA	700	70 kA	400	
	317	30 kA	800	30 kA	800	69 kA	500	
	361	30 kA	1000	30 kA	1000	69 kA	600	
	480	42 kA	1200	42 kA	1200	69 kA	800	
	625	42 kA	1600	42 kA	1600	74 kA	1600	
	780	42 kA	1600	42 kA	2000	74 kA	1600	
	970	85 kA	2500	85 kA	2500	85 kA	2500	
	1250	85 kA	3000	85 kA	3200	85 kA	3000	
	Delta Device Operational Current Rating (A)	8.7	5 kA	35	5 kA	35	70 kA	17.5
		43	5 kA	150	5 kA	150	70 kA	90
		74	10 kA	300	10 kA	300	70 kA	150
		104	10 kA	400	10 kA	400	70 kA	200
147		10 kA	400	10 kA	400	70 kA	200	
187		10 kA	600	10 kA	500	70 kA	300	
234		10 kA	700	10 kA	700	70 kA	400	
348		18 kA	1000	18 kA	1000	70 kA	600	
435		18 kA	1200	18 kA	1200	70 kA	800	
549		30 kA	1600	30 kA	1600	69 kA	1000	
625		30 kA	1600	30 kA	1600	69 kA	1200	
831		42 kA	1600	30 kA	1600	69 kA	1600	
850		42 kA	1600	42 kA	2000	74 kA	1600	
900		42 kA	1600	42 kA	2000	74 kA	1600	
1200		85 kA	3000	85 kA	3200	85 kA	3000	
1600		85 kA	3000	85 kA	3200	85 kA	3000	
Semi-Conductor Fusing	Device Rating	Max. Standard Available Fault	Max. Ampere tested - North American Style		Max. Ampere Tested - European Style			
	108	70 kA	A070URD33xxx500		6.9 gRB 73xxx400 6.6URD33xxx500			
	135	70 kA	A070URD33xxx500		6.9 gRB 73xxx400 6.6URD33xxx500			
	201	70 kA	A070URD33xxx700		6.9 gRB 73xxx630 6.6URD33xxx700			
	251	70 kA	A070URD33xxx700		6.9 gRB 73xxx630 6.6URD33xxx700			
	317	70 kA	A070URD33xxx900		6.9 gRB 73xxx800 6.6URD33xxx900			
	361	70 kA	A070URD33xxx900		6.9 gRB 73xxx800 6.6URD33xxx900			
	480	70 kA	A070URD33xxx1250 A100URD73xxx1250		9 URD 73xxx1250 6.6URD33xxx1250			
	625	70 kA	A070URD33xxx1400		6.6URD33xxx1400			
	780	70 kA	A070URD33xxx1400		6.6URD33xxx1400			
	970	85 kA	Two fuses in parallel A070URD33xxx1250		Two fuses in parallel 6.6URD33xxx1250			
	1250	85 kA	Two fuses in parallel A070URD33xxx1250		Two fuses in parallel 6.6URD33xxx1250			
	SCCR ④	Maximum FLC	Device Rating	Max. Standard Available Fault	Max. Ampere tested - North American Style		Max. Ampere Tested - European Style	
108			70 kA	A070URD33xxx500		6.9 gRB 73xxx400 6.6URD33xxx500		
135			70 kA	A070URD33xxx500		6.9 gRB 73xxx400 6.6URD33xxx500		
201			70 kA	A070URD33xxx700		6.9 gRB 73xxx630 6.6URD33xxx700		
251			70 kA	A070URD33xxx700		6.9 gRB 73xxx630 6.6URD33xxx700		
317			70 kA	A070URD33xxx900		6.9 gRB 73xxx800 6.6URD33xxx900		
361			70 kA	A070URD33xxx900		6.9 gRB 73xxx800 6.6URD33xxx900		
480			70 kA	A070URD33xxx1250 A100URD73xxx1250		9 URD 73xxx1250 6.6URD33xxx1250		
625			70 kA	A070URD33xxx1400		6.6URD33xxx1400		
780			70 kA	A070URD33xxx1400		6.6URD33xxx1400		
970			85 kA	Two fuses in parallel A070URD33xxx1250		Two fuses in parallel 6.6URD33xxx1250		
1250			85 kA	Two fuses in parallel A070URD33xxx1250		Two fuses in parallel 6.6URD33xxx1250		

① Consult local codes for proper sizing of short circuit protection.  
 ② Non-time delay fuses (K5 – 5 ...480V (8.7...831 A) devices; Class L – 625...1250V (850...1600 A) devices).  
 ③ High capacity fault rating when used with time delay class CC, J, or L fuses.

④ Type 1 performance/protection indicates that, under a short-circuit condition, the fused or circuit breaker-protected starter shall cause no danger to persons or installation but may not be suitable for further service without repair or replacement.



Electrical Ratings		120..240V AC	Transformer	75 VA	
Power Requirements	Control Module	24V AC	Transformer	130 VA	
		24V DC	Inrush Current	5 A	
	Inrush Time		250 ms		
	Transient Watts		60 W		
	Transient Time		500 ms		
	Steady State Watts		24 W		
	Minimum Power Supply		FLEX6024A		
		625...1250 A	751 VA (recommended 800 VA)		
	Heatsink Fan(s) (A) ❶		5...135 A, 20 VA		
			201...251 A, 40 VA		
		317...480 A, 60 VA			
		625...1250 A, 150 VA			
Steady State Heat Dissipation with Control and Fan Power (Watts)	Controller Rating (A)	5	70		
		23	70		
		43	81		
		60	97		
		85	129		
		108	91		
		135	104		
		201	180		
		251	198		
		317	225		
		361	245		
		480	290		
		625	446		
		780	590		
970	812				
1250	1222				
Auxiliary Contacts 19/20 (Aux #1) 29/30 (Aux #2) 31/32 (Aux #3) 33/34 (Aux #4)	Type of Control Circuit	Electromagnetic relay			
	Number of Contacts	1			
	Type of Contacts	programmable N.O./N.C.			
	Type of Current	AC			
	Rated Optional Current	3 A @ 120V AC, 1.5 A @ 240V AC			
	Conventional Thermal Current $I_{th}$	5 A			
	Make/Break VA	3600/360			
	Utilization Category	AC-15			
PTC Input Ratings	Response Resistance	3400 $\Omega \pm 150 \Omega$			
	Reset Resistance	1600 $\Omega \pm 100 \Omega$			
	Short-Circuit Trip Resistance	25 $\Omega \pm 10 \Omega$			
	Max. Voltage at PTC Terminals ( $R_{PTC} = 4k$ )	< 7.5V			
	Max. Voltage at PTC Terminals ( $R_{PTC} = open$ )	30V			
	Max. No. of Sensors	6			
	Max. Cold Resistance of PTC Sensor Chain	1500 $\Omega$			
Tach input	Response Time	800 ms			
		0...5V DC, 4.5V DC = 100% Speed			

Environmental	
Operating Temperature Range	-5...50 °C (23...122 °F) (open) -5...40 °C (23...104 °F) (enclosed)
Storage and Transportation Temperature Range	-20...+75 °C (-4...167 °F)
Altitude	2000 m (6560 ft)
Humidity	5...95% (non-condensing)
Pollution Degree	2

❶ For devices rated 5...480 A, heatsink fans can be powered by either 110/120V AC or 220/240V AC.  
For devices rated 625...1250 A, heatsink fans can only be powered by 110/120V AC.

Mechanical				
Resistance to Vibration	Operational	All	1.0 G Peak, 0.15 mm (0.006 in.) displacement	
	Non-Operational	5...480 A 625...1250 A	2.5 G Peak, 0.38 mm (0.015 in.) displacement 1.0 G Peak, 0.15 mm (0.006 in.) displacement	
Resistance to Shock	Operational	5...85 A	15 G	
		108...480 A	5.5 G	
		625...1250 A	4 G	
	Non-Operational	5...85 A	30 G	
		108...480 A	25 G	
		625...1250 A	12 G	
Construction	Power Poles	5...85 A	Heatsink thyristor modular design	
	Power Poles	108...1250 A	Heatsink hockey puck thyristor modular design	
	Control Modules		Thermoset and Thermoplastic Moldings	
	Metal Parts		Plated Brass, Copper or Painted Steel	
Terminals	Power Terminals	5...85 A	Cable size – Line Upper – 2.5...95 mm <sup>2</sup> (14...3/0 AWG) Line Lower – 0.8...2.5 mm <sup>2</sup> (18...14 AWG) Load Upper – 2.5...50 mm <sup>2</sup> (14...1 AWG) Load Lower – 0.8...2.5 mm <sup>2</sup> (18...14 AWG) Tightening torque – 14.7 N•m (130 lb.-in.) Wire strip length – 18...20 mm (0.22...0.34 in.)	
		108...135 A	One M10 x 1.5 diameter hole per power pole	
		201...251 A	Two M10 x 1.5 diameter holes per power pole	
		317...480 A	Two M12 x 1.75 diameter holes per power pole	
		625...1250 A	Two 13.5 mm (0.53 in.) diameter holes per power pole	
	Power Terminal Markings		NEMA, CENELEC EN50 012	
	Control Terminals	M3 screw clamp	Clamping yoke connection	
Other				
EMC Emission Levels	Conducted Radio Frequency Emissions Radiated emissions		Class A Class A	
EMC Immunity Levels	Electrostatic Discharge Radio Frequency Electromagnetic Field Fast Transient Surge Transient		B kV Air Discharge Per EN/IEC 60947-4-2 Per EN/IEC 60947-4-2 Per EN/IEC 60947-4-2	
Overload Characteristics	Current Range		Line	Delta
		5	1...5	1.7...9
		25	5...25	8.6...43
		43	8.6...43	14.8...75
		60	12...60	20.8...104
		85	17...85	29.4...147
		108	27...108	47...187
		135	34...135	59...234
		201	67...201	116...348
		251	84...251	145...435
		317	106...317	183...549
		361	120...361	208...625
		480	160...480	277...831
		625	208...625	283...850
		780	260...780	300...900
970	323...970	400...1200		
1250	416...1250	533...1600		
	Trip Classes		10, 15, 20, and 30	
	Trip Current Rating		117% of Motor FLC	
	Number of Poles		3	
Certifications	Open Type Controllers		CE Marked Per Low Voltage Directive 73/23/EEC, 93/68/EEC UL Listed (File No. E195687)	

**Soft Stop, Pump Control and Braking Wiring Diagram**

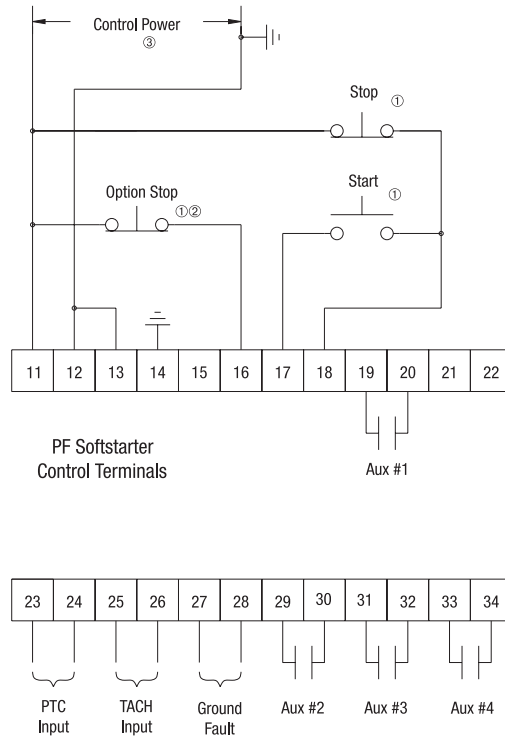

**3-Wire Control**

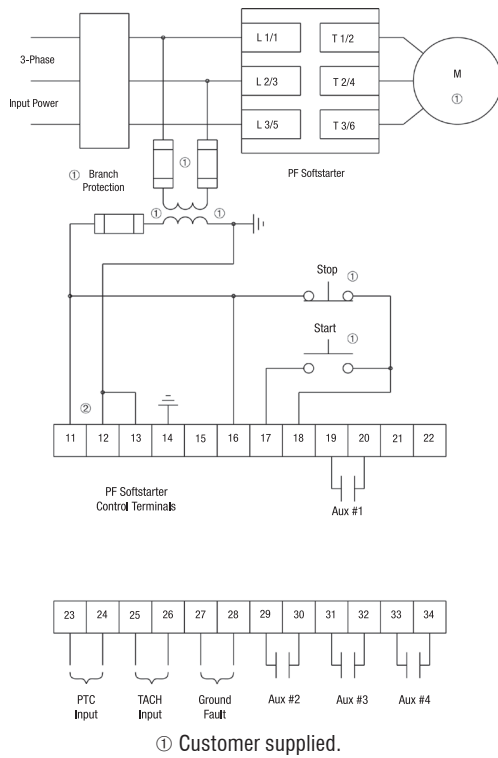

**2-Wire Control**

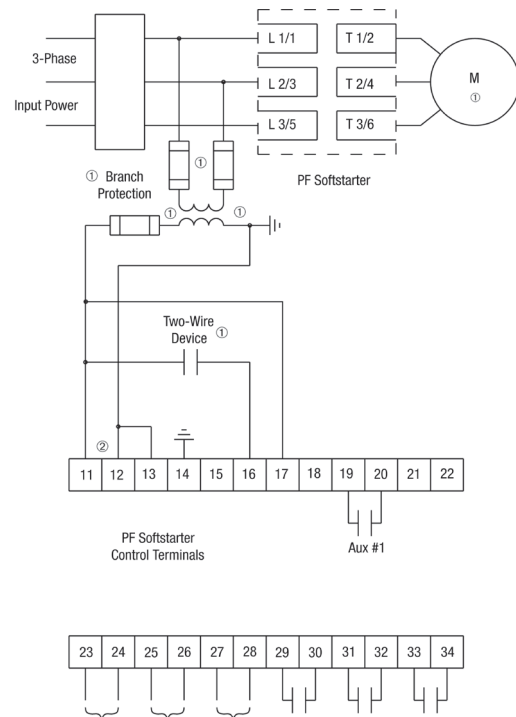

Approximate Dimensions and Shipping Weights

**Open Type Controllers**

Dimensions are in millimeters (inches). Dimensions not intended for manufacturing purposes.

Rating (A)	Height	Width	Depth	Weight
5...85	321 (12.6)	150 (5.9)	203 (8.0)	5.7 kg (12.6 lbs)
108...135	443.7 (17.47)	196.4 (7.74)	205.2 (8.08)	15.0 kg (33 lbs)
201...251	560 (22.05)	225 (8.86)	253.8 (9.99)	304 kg (67 lbs)
317...480	600 (23.62)	290 (11.42)	276.5 (10.89)	45.8 kg (101 lbs)
625...780	1041.1 (41.0)	596.9 (23.5)	346.2 (13.63)	179 kg (395 lbs)
970...1250	1041.1 (41.0)	596.9 (23.5)	346.2 (13.63)	224 kg (495 lbs)

**D**  
PFS Softstarters

**Enclosed Type Line-Connected Controllers**

**IMPORTANT NOTE:**

Factory-installed options may affect enclosure size requirements.  
Exact dimensions can be obtained after order entry.  
Please consult your local Sprecher + Schuh representative.

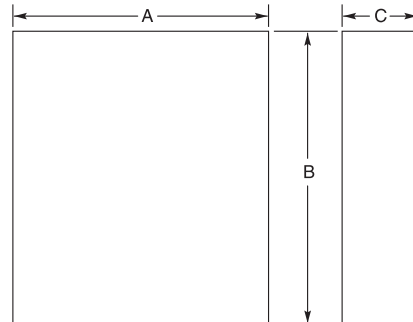

Controller Rating (A)	Disconnect Rating (A)	IP65 (Type 4/12)		
		Height B	Width A	Depth C
<b>Non-Combination Controller</b>				
5	—	610 (24)	508 (20)	254 (10)
25	—	610 (24)	508 (20)	254 (10)
43	—	610 (24)	508 (20)	254 (10)
60	—	610 (24)	508 (20)	254 (10)
85	—	610 (24)	508 (20)	254 (10)
108	—	762 (30)	610 (24)	305 (12)
135	—	762 (30)	610 (24)	305 (12)
201	—	914 (36)	762 (30)	406 (16)
251	—	914 (36)	762 (30)	406 (16)
317	—	1524 (60)	914 (36)	406 (16)
361	—	1524 (60)	914 (36)	406 (16)
480	—	1524 (60)	914 (36)	406 (16)
625	—	2286 (90)	1829 (72)	508 (20)
780	—	2286 (90)	1829 (72)	508 (20)
970 ①	—	2286 (90)	1829 (72)	508 (20)
1250 ①	—	2286 (90)	1829 (72)	508 (20)

① 970...1250 rated devices are only available as Type 1 and require a door-mounted fan, capable of delivering 204 cfm.

Approximate Dimensions ④

**Enclosed Type Line-Connected Combination Controllers**

**IMPORTANT NOTE:**

Factory-installed options may affect enclosure size requirements.  
Exact dimensions can be obtained after order entry.  
Please consult your local Sprecher + Schuh representative.

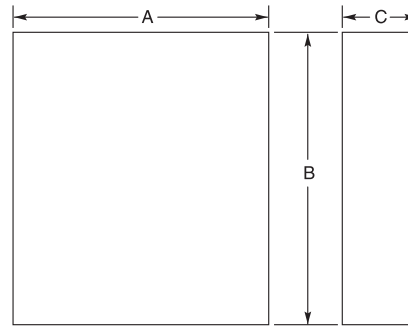

Controller Rating (A)	Disconnect Rating (A)	IP65 (Type 4/12)		
		Height B	Width A	Depth C
<b>Combination Controllers with Fusible Disconnect</b>				
5	30 A/J	610 (24)	508 (20)	254 (10)
25	30 A/J	610 (24)	508 (20)	254 (10)
43	60 A/J	610 (24)	508 (20)	254 (10)
60	100 A/J	610 (24)	508 (20)	254 (10)
85	100 A/J	610 (24)	508 (20)	254 (10)
108	200 A/J	914 (36)	762 (30)	406 (16)
135	200 A/J	914 (36)	762 (30)	406 (16)
201	400 A/J	1219 (48)	914 (36)	406 (16)
251	400 A/J	1219 (48)	914 (36)	406 (16)
317	600 A/J	1524 (60)	914 (36)	406 (16)
361 <sup>①</sup>	600 A/J	1524 (60)	914 (36)	406 (16)
480 <sup>②</sup>	600 A/J	1524 (60)	914 (36)	406 (16)
	800 A/L	2286 (90)	508 (20)	508 (20)
625	—	2286 (90)	1829 (72)	508 (20)
780	—	2286 (90)	1829 (72)	508 (20)
970 <sup>③</sup>	—	2286 (90)	1829 (72)	508 (20)
1250 <sup>③</sup>	—	2286 (90)	1829 (72)	508 (20)
<b>Combination Controllers with Circuit Breaker</b>				
5	15 A	610 (24)	508 (20)	254 (10)
25	30 A	610 (24)	508 (20)	254 (10)
43	80 A	610 (24)	508 (20)	254 (10)
60	100 A	610 (24)	508 (20)	254 (10)
85	125 A	610 (24)	508 (20)	254 (10)
108	175 A/175 A Plug	914 (36)	762 (30)	406 (16)
135	225 A/225 A Plug	914 (36)	762 (30)	406 (16)
201	300 A/300 A Plug	1219 (48)	914 (36)	406 (16)
251	400 A/400 A Plug	1219 (48)	914 (36)	406 (16)
317	600 A/500 A Plug	1524 (60)	914 (36)	406 (16)
361	600 A/600 A Plug	1524 (60)	914 (36)	406 (16)
480	800 A/800 A Plug	1524 (60)	914 (36)	406 (16)
625	—	2286 (90)	1829 (72)	508 (20)
780	—	2286 (90)	1829 (72)	508 (20)
970 <sup>②</sup>	—	2286 (90)	1829 (72)	508 (20)
1250 <sup>③</sup>	—	2286 (90)	1829 (72)	508 (20)

- ① Use this row for 460V -58 and 575V -59.
- ② Use this row for 460V -59 and 575 -60 and -61.
- ③ 970...1250 rated devices are only available as Type 1 and require a door-mounted fan, capable of delivering 240 cfm.
- ④ These dimensions are to be considered the recommended minimal enclosure dimensions and do not represent actual Sprecher + Schuh assembled product dimensions. Consult your local Sprecher + Schuh representative for details.

**D**  
PFS Softstarters

# PCEC Hydraulic Elevator Softstarters up to 150 HP @ 480 VAC

Unique advantages not found in electromechanical or other solid state starters

PCEC Hydraulic Elevator Softstarters



The PCE Hydraulic Elevator Softstarter and PCEC Panel Solution by Sprecher+Schuh are designed to simplify installation, set-up, and typical operation of motors that drive hydraulic elevators and escalators. This solid state starter solution is designed to operate 3 phase standard squirrel cage induction motors and can be connected to a 6 or 12 lead Wye-Delta (Star-Delta) or standard 3 or 9 lead motors. Through the use of LINE or INSIDE-THE-DELTA control, the solid state solution can provide ultimate control of the motor. The advantages of a solid state solution include the following:

### Provides smooth motor starting

- Decreases current surges on weak electrical systems
- Reduced starting torque of the motor helps to reduce mechanical stress on system components
- Helps meet both local and regional electrical codes when reduced voltage starting is a requirement
- Eliminates voltage and current spikes associated with traditional Wye-Delta (Star-Delta) starters
- Maximizes motor life due to reduced electrical strain
- Lowers general system maintenance requirements for improved uptime

The PCEC panel solution provides a standard PCE controller and a factory coordinated fault contactor on a common mounting plate for ease of installation. The PCE controller utilizes software optimized for the elevator industry along with a built-in selectable Class 10, 15 and 20 overload relay and SCR bypass to control all three phases. The pre-wired control harness (3 ft / ~1m flying leads) is supplied to simplify wiring into current installations while the mounting plate holes are the same as many standard Wye-Delta electro-mechanical starter panels. To insure start up performance both the PCE controller and PCEC panel assembly are factory tested before shipping.

The result is a quick and easy starter solution for the elevator and escalator industries.

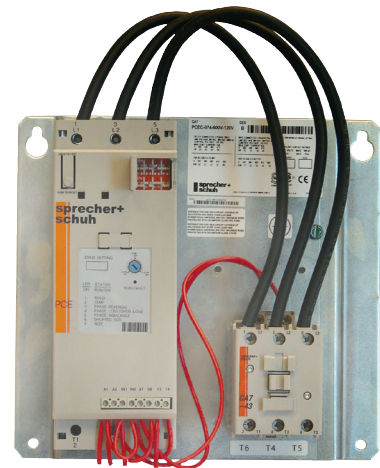

### Microprocessor control provides precision operation

PCEC softstarters are under full microprocessor control, which limits starting current to the preset adjustable value. Current never exceeds the preset limit. Microprocessor control also provides finer increments of adjustment, facilitating smooth, repeatable, and accurate starting characteristics, independent of component aging and varying environmental conditions.

### LED diagnostic display

An LED display indicates operating status and fault condition (overload, over temperature, phase reversal/phase loss, phase imbalance, shorted SCR, start fault). This enables speedy diagnosis and quick resolution of problems.

### Standard fault contactor

The PCEC panel solution is equipped with a standard fault contactor which isolates one side of the motor windings from the line power in case of softstarter fault or motor overload. Current flow is prevented by this mechanical isolation in addition to the solid state SCRs.

### UL/CSA Elevator Ratings

The PCEC Softstarters are UL Listed and cUL Listed (Canadian Standards per UL 508 and CS C22.2 No. 14-95) as solid state motor controllers in File E96956. They are also UL Listed and cUL Listed per UL 508 and CAN/CSA B44.1-96 as elevator controllers in File E3125.

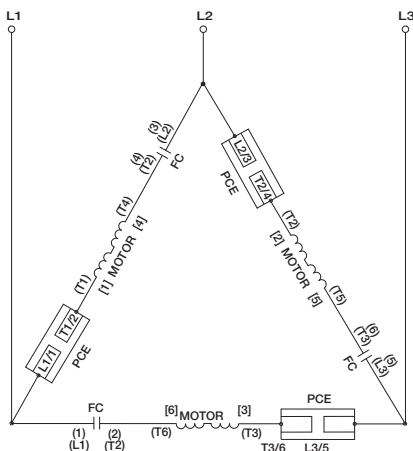

PCEC Hydraulic Elevator Softstarters are wired "inside the delta" for more efficient operation and retrofit



# PCEC Hydraulic Elevator Softstarters up to 150 HP @ 480 VAC

Unique advantages not found in electromechanical or other solid state starters

PCEC Hydraulic Elevator Softstarters



The PCE Hydraulic Elevator Softstarter and PCEC Panel Solution by Sprecher+Schuh are designed to simplify installation, set-up, and typical operation of motors that drive hydraulic elevators and escalators. This solid state starter solution is designed to operate 3 phase standard squirrel cage induction motors and can be connected to a 6 or 12 lead Wye-Delta (Star-Delta) or standard 3 or 9 lead motors. Through the use of LINE or INSIDE-THE-DELTA control, the solid state solution can provide ultimate control of the motor. The advantages of a solid state solution include the following:

### Provides smooth motor starting

- Decreases current surges on weak electrical systems
- Reduced starting torque of the motor helps to reduce mechanical stress on system components
- Helps meet both local and regional electrical codes when reduced voltage starting is a requirement
- Eliminates voltage and current spikes associated with traditional Wye-Delta (Star-Delta) starters
- Maximizes motor life due to reduced electrical strain
- Lowers general system maintenance requirements for improved uptime

The PCEC panel solution provides a standard PCE controller and a factory coordinated fault contactor on a common mounting plate for ease of installation. The PCE controller utilizes software optimized for the elevator industry along with a built-in selectable Class 10, 15 and 20 overload relay and SCR bypass to control all three phases. The pre-wired control harness (3 ft / ~1m flying leads) is supplied to simplify wiring into current installations while the mounting plate holes are the same as many standard Wye-Delta electro-mechanical starter panels. To insure start up performance both the PCE controller and PCEC panel assembly are factory tested before shipping.

The result is a quick and easy starter solution for the elevator and escalator industries.

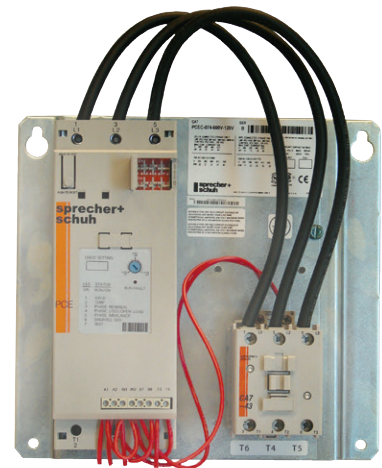

### Microprocessor control provides precision operation

PCEC softstarters are under full microprocessor control, which limits starting current to the preset adjustable value. Current never exceeds the preset limit. Microprocessor control also provides finer increments of adjustment, facilitating smooth, repeatable, and accurate starting characteristics, independent of component aging and varying environmental conditions.

### LED diagnostic display

An LED display indicates operating status and fault condition (overload, over temperature, phase reversal/phase loss, phase imbalance, shorted SCR, start fault). This enables speedy diagnosis and quick resolution of problems.

### Standard fault contactor

The PCEC panel solution is equipped with a standard fault contactor which isolates one side of the motor windings from the line power in case of softstarter fault or motor overload. Current flow is prevented by this mechanical isolation in addition to the solid state SCRs.

### UL/CSA Elevator Ratings

The PCEC Softstarters are UL Listed and cUL Listed (Canadian Standards per UL 508 and CS C22.2 No. 14-95) as solid state motor controllers in File E96956. They are also UL Listed and cUL Listed per UL 508 and CAN/CSA B44.1-96 as elevator controllers in File E3125.

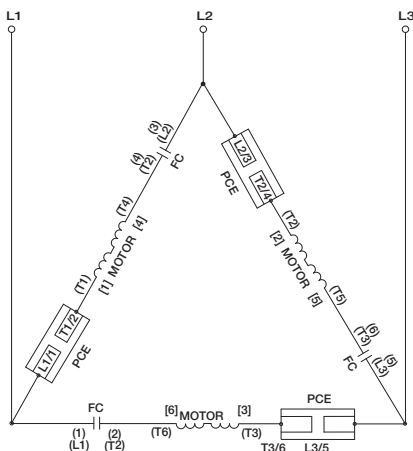

PCEC Hydraulic Elevator Softstarters are wired "inside the delta" for more efficient operation and retrofit

**Current Limit Starting**

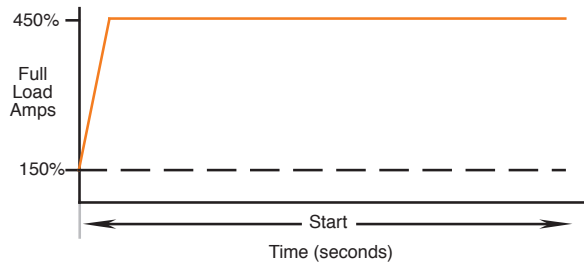

Through the use of internal current sensors, the PCEC will regulate the current level applied to the motor over the programmed period of time. This type of motor control produces a slow start and insures that the current does not exceed the programmed level. This is standard configuration of the device and aligns well with traditional applications.

**Soft Start**

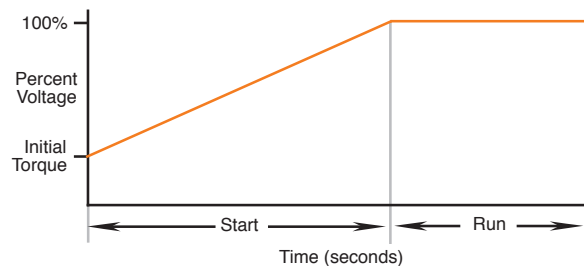

During Soft start, the voltage is ramped from an initial set point to full voltage over the programmed period of time. This type of motor control produces a smooth start in less time than the current limit setting, however the current is not restricted.

**Soft Stop**

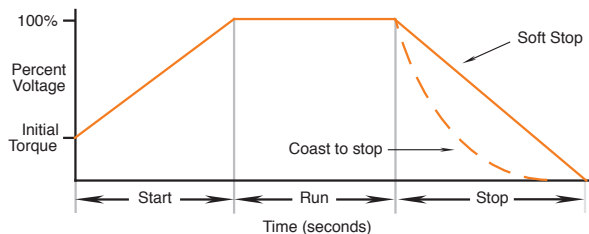

Soft stop provides the ability to ramp down the voltage applied to the motor over a programmed period of time. The result is a smooth stop.

**Diagnostics**

Overload	The built in motor overload provides protection of the motor for over current conditions. This protection feature offers a user selectable setting called the trip class, which can be used to accommodate different applications and motor types. When the motor draws more than the nominal value of current for a period of time, the device will fault on a motor overload fault.
Over Temperature	The product includes a built in self monitoring method for detecting a SCR over-temperature condition. If the internal temperature exceeds a design threshold the device will fault on a SCR Overtemp fault.
Phase Reversal	The user can select the phase relationship of the incoming power. If this phase relationship changes, the device will fault indicating a problem.
Phase Loss/Open Load	When any one of the incoming 3 phases are lost, the controller will fault indicating a phase loss condition has occurred.
Phase Imbalance	When enabled, this motor protection feature will detect if a phase imbalance condition exists and fault the unit. A phase imbalance is defined as a 65% differential between the highest and lowest phase for more than 3 seconds.
Shorted SCR	Each time the PCEC initiates a start, it checks to see if the SCR's are operating correctly. If the controller is unable to properly turn on and off any one of the SCR's, the device will fault on a Shorted SCR fault.

**D**  
PCEC Hydraulic Elevator Softstarters

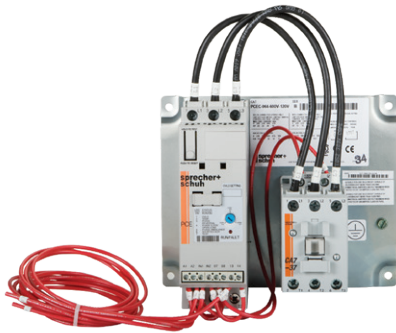

Frame Size 1 - 32...64 Amp



Frame Size 2 - 74...147 Amp

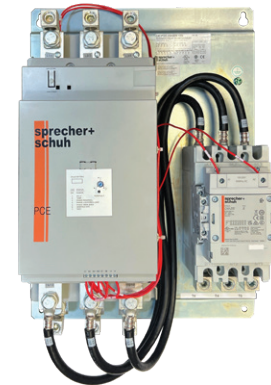

Frame Size 3 - 234 Amp

### PCEC Controller Panel - 120V Control Voltage ④⑥

DELTA Connected - 6 Wire ②					Line Connected - 3 Wire ②					Frame Size	With 120VAC 50/60 Hz ②③ Control Voltage Catalog Number
Maximum Horsepower				Overload Range ①	Maximum Horsepower				Overload Range ①		
200V	240V	480V	575V		200V	240V	480V	575V			
10	10	20	30	10.9...32.9	5	5	10	15	6.3...19	1	PCEC-032-600V-120V
15	15	30	40	17...51	7.5	10	20	25	10...30	1	PCEC-051-600V-120V
20	20	40	60	21.3...64	10	10	25	30	12.3...37	1	PCEC-064-600V-120V
20	25	50	60	24.7...74	10	15	30	40	14.3...43	2	PCEC-074-600V-120V
30	40	75	100	34.7...104	15	20	40	50	20...60	2	PCEC-104-600V-120V
40	50	100	150	49...147	25	30	60	75	28.3...85	2	PCEC-147-600V-120V
75	75	150	200	59...234	40	50	100	125	34...135	3	PCEC-234-600V-120V ⑤

### PCEC Controller Panel - 230V Control Voltage ④⑥

DELTA Connected - 6 Wire ②					Line Connected - 3 Wire ②					Frame Size	With 230VAC 50/60 Hz ②③ Control Voltage Catalog Number
Maximum Horsepower				Overload Range ①	Maximum Horsepower				Overload Range ①		
200V	240V	480V	575V		200V	240V	480V	575V			
10	10	20	30	10.9...32.9	5	5	10	15	6.3...19	1	PCEC-032-600V-230V
15	15	30	40	17...51	7.5	10	20	25	10...30	1	PCEC-051-600V-230V
20	20	40	60	21.3...64	10	10	25	30	12.3...37	1	PCEC-064-600V-230V
20	25	50	60	24.7...74	10	15	30	40	14.3...43	2	PCEC-074-600V-230V
30	40	75	100	34.7...104	15	20	40	50	20...60	2	PCEC-104-600V-230V
40	50	100	150	49...147	25	30	60	75	28.3...85	2	PCEC-147-600V-230V
75	75	150	200	59...234	40	50	100	125	34...135	3	PCEC-234-600V-230V ⑤

- ① Motor FLA must fall within the specified range to operate correctly.
- ② The PCEC Controller panel powerwire jumpers and parameter DIP switch settings are shipped in the DELTA connection mode by default. LINE connection requires the power wires to be reconfigured and DIP Switch #15 to be programmed for LINE connection mode by the customer.
- ③ Internal fan is optional for PCEC-032...064. See page D19 to purchase separately. All other PCEC units have internal fan as standard.
- ④ Purchase additional PCE Auxiliary Contact Blocks separately. See page D30. One Auxiliary Contact Block (one or two pole) may be mounted on the right side of the PCE controller.

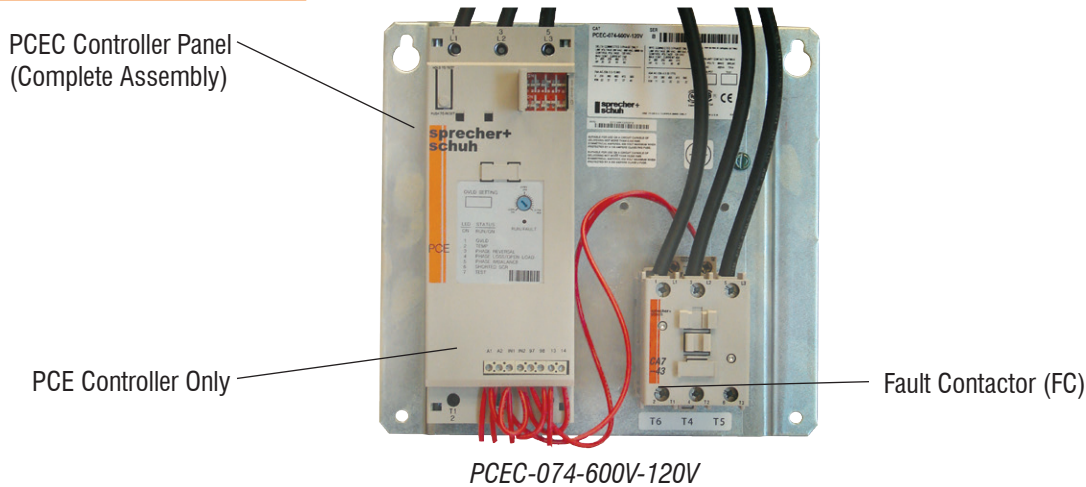

- ⑤ Separate 120V or 240V single phase is required for PCEC fan operation.
- ⑥ The PCEC Hydraulic Elevator duty rating is 80 starts per hour at 50% duty cycle (160 calls per hour). Starts per hour are based on when the motor starts, the motor only runs on "up" calls. Installing an optional fan (PCV-64) is recommended for PCEC-032A...064A for maximum starts per hour performance. All other PCEC units have an internal fan as standard.



### Replacement Parts

Complete Assembly (For Reference Only)	PCE Controller Only	PCE Fans	Fault Contactor	Fault Contactor Coil	
PCEC-032-600V-120V	<b>PCE-032-600V</b>	PCV-064 (optional)	CA7-37-00-120	TC473	
PCEC-051-600V-120V	<b>PCE-051-600V</b>		CA7-37-00-120		
PCEC-064-600V-120V	<b>PCE-064-600V</b>		CA7-37-00-120		
PCEC-074-600V-120V	<b>PCE-074-600V</b>	PCV-147	CA7-43-00-120	TD473	
PCEC-104-600V-120V	<b>PCE-104-600V</b>		CA7-60-00-120	TE473	
PCEC-147-600V-120V	<b>PCE-147-600V</b>		CA7-85-00-120	TE473	
PCEC-234-600V-120V	Complete Device	PCV-234	CA9-190-11-120W	CA9-TG907	
	Control Module				<b>PCE-234</b>
	Power Pole				<b>PFL-0135-600V ①</b>
	Terminal Cover				<b>PFT-0135</b>
PCEC-032-600V-230V	<b>PCE-032-600V</b>	PCV-064 (optional)	CA7-37-00-220W	TC296	
PCEC-051-600V-230V	<b>PCE-051-600V</b>		CA7-37-00-220W		
PCEC-064-600V-230V	<b>PCE-064-600V</b>		CA7-37-00-220W		
PCEC-074-600V-230V	<b>PCE-074-600V</b>	PCV-147	CA7-43-00-220W	TD296	
PCEC-104-600V-230V	<b>PCE-104-600V</b>		CA7-60-00-220W	TE296	
PCEC-147-600V-230V	<b>PCE-147-600V</b>		CA7-85-00-220W	TE296	
PCEC-234-600V-230V	Complete Device	PCV-234	CA9-190-11-120W	CA9-TG907	
	Control Module				<b>PCE-234</b>
	Power Pole				<b>PFL-0135-600V ①</b>
	Terminal Cover				<b>PFT-0135</b>

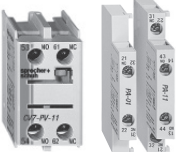
### Optional Accessories

	See page D30 for PCE Controller Auxiliaries		See page A47 for Fault Contactor Front and Side Mount Auxiliaries		See page D19 for Protection Modules		See page D19 for Internal Fan
---	---	---	---	---	-------------------------------------	---	-------------------------------

① Part number contains three power poles.

**Electrical**

<b>Power Circuit</b>		<b>UL/cUL/CSA</b>	<b>IEC</b>
Rated Operational Voltage		200...600V AC	200...500V~
Rated Insulation Voltage		600V AC	500V~
Dielectric Withstand		2200V AC	2500V~
Repetitive Peak		200...600V AC: 1600	500V~: 1600
Rated Impulse Voltage		6 kV	
Over-voltage Category		III	
Number of Poles		Equipment designed for 3 phase only	
Operating Frequency		50/60 Hz	
Controller Utilization Category		32/51/64	AC-53b: 3.5-15:3585
		74/104/147	AC-53b: 4.5-30:1770
		234	AC-53b: 3.5-30:1770
Overload Current Range (Amps)		LINE	DELTA
	32	6.3...19	10.9...32.8
	51	10...30	17...51
	64	12.3...37	21.3...64
	74	14.3...43	24.7...74
	104	20...60	34.7...104
	147	28.3...85	49 ...147
	234	34...135	59...234
<b>Control Circuit</b>		<b>UL/cUL/CSA</b>	<b>IEC</b>
Rated Operational Voltage		100...120 V AC, 200...240V AC	120~, 240~
Rated Insulation Voltage		NA	300V~
Dielectric Withstand		NA	3000V
Rated Impulse Voltage		3kV	
Operating Frequency		50/60 Hz	
Control Power Requirements		32/51/64	215 mA @ 120 V AC , 180 mA @ 240 V AC
		74/104/147	200 mA @ 120 V AC , 100 mA @ 240 V AC
		234	200 mA @ 120 V AC , 120 mA @ 240 V AC
Fan Power Requirements		32/51/64	NA
		74/104/147	NA
		234	20 VA

**Electrical (continued)**

<b>Short Circuit Performance</b>		<b>Type 1</b>	
Device Current Rating	Max Fuse Size and Type	Max Available Fault Rating	
32	70 A - RK5	5 kA	
	125 A - K5	5 kA	
51	125 A - RK5	5 kA	
	200 A - K5	10 kA	
64	125 A - RK5	5 kA	
	200 A - K5	10 kA	
74	150 A - RK5	5 kA	
	250 A - J	10 kA	
104	200 A - RK5	5 kA	
	400 A - J	10 kA	
147	250 A - RK5	10 kA	
	400 A - J	10 kA	
234	400 A - RK5	10 kA	
	450 A - K5	10 kA	

<b>Auxiliary Contacts (Fault and Aux#1)</b>	<b>UL/cUL/CSA</b>	<b>IEC</b>
Rated Operational Voltage	250V AC / 30V DC	250V~ / 30V DC
Rated Insulation Voltage	250V	250V~
Rated Impulse Voltage	NA	4kV
Dielectric Withstand	1500V AC	2000V~
Operating Frequency	50/60 Hz	
Utilization Category	D300	AC-15 / DC
Type of Control Circuit	Electromagnetic Relay	
Number of Contacts	1	
Type of contacts	Normally Open (N.O.)	
Type of current	AC/DC	
Rated Operational Current (Max.)	0.6 A @ 120 V~ and 0.3 A @ 240V~	
Conventional Thermal Current (I <sub>th</sub> )	1 Amp	
Make/Break VA	432/72	

**Mechanical**

Resistance to Vibration	Operational	1.0 G Peak, 0.15 mm (0.006 in) displacement
	Non-operational	2.5 G Peak, 0.38 mm (0.015 in) displacement
Resistance to Shock	Operational	15 G
	Non-operational	5.5 G

**Environmental**

Operating Temperature	0...50°C (32...122°F) Open
	0...40°C (32...104°F) Enclosed
Altitude	2000 m (6560 ft)
Humidity	5...95% (non-condensing)
Pollution Degree	2

**UL/CSA Elevator Ratings**

The PCEC Softstarters are UL Listed and cUL Listed (Canadian Standards per UL 508 and CS C22.2 No. 14-95) as solid state motor controllers in File E96956. They are also UL Listed and cUL Listed per UL 508 and CAN/CSA B44.1-96 as elevator controllers in File E3125.

**D**  
**PCEC Hydraulic Elevator Softstarters**



### Motor FLA Adjustments

The front of the PCE controller contains a dial which is used for setting the actual FLA of the motor. The label is designed to accommodate motors connected in the LINE or DELTA mode. To determine the proper setting, look at the motors nameplate and set the dial accordingly. The dial setting can be modified depending on the service factor of the motor as shown:

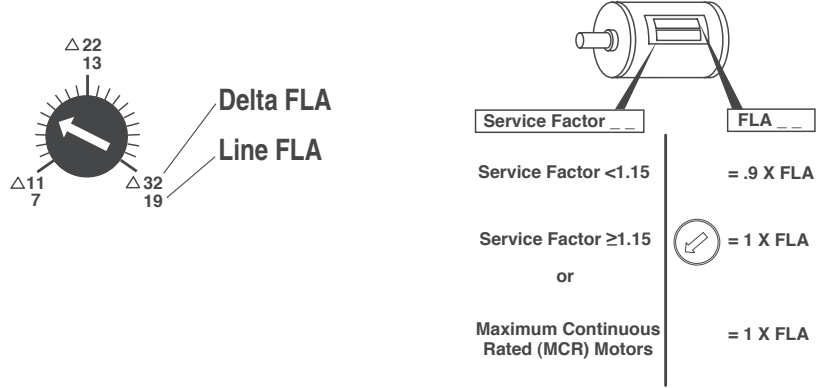

### Motor Overload Trip Curves

The trip class should be set according to the motors maximum permissible locked rotor time or the general thermal capabilities. Consult the motor manufacturer for recommendations on setting the trip class.

--- Hot    — Cold

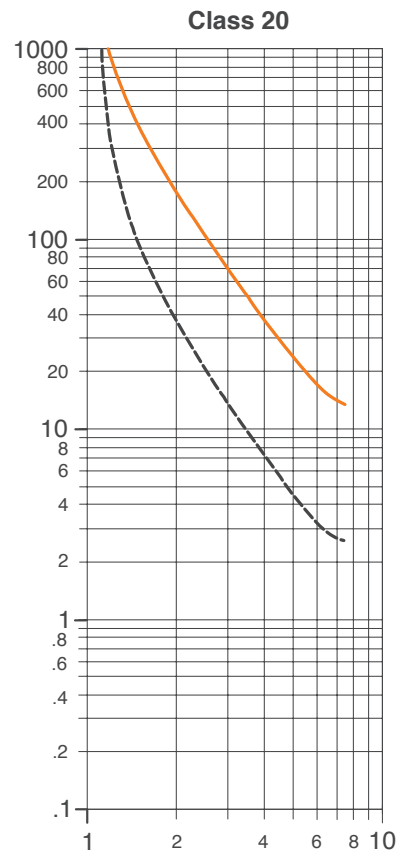
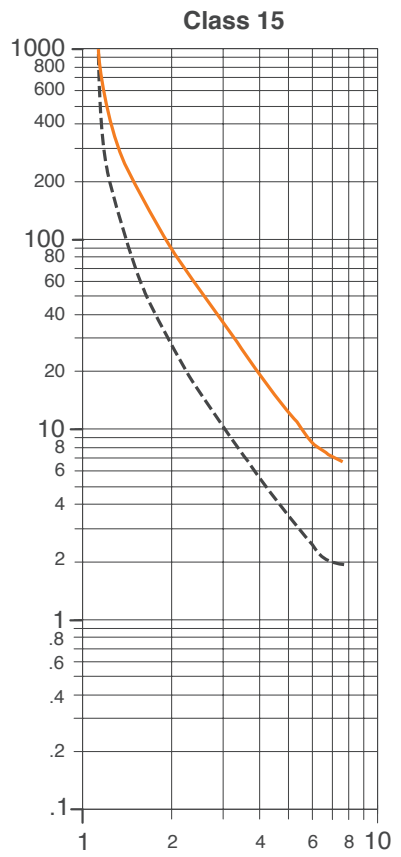
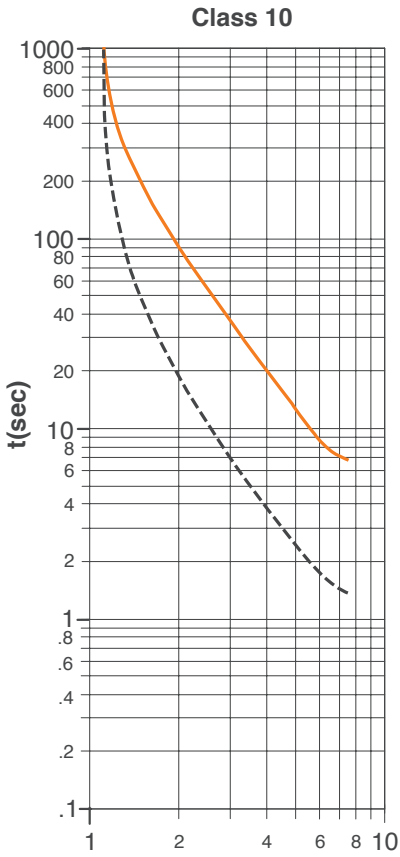

**DELTA Connection Diagrams, Power, and Motor Wiring**

- 1- CONTROL POWER (L)
- 2- CONTROL COMMON (N)
- 4- START ENABLE
- 13- UP TO SPEED INDICATION

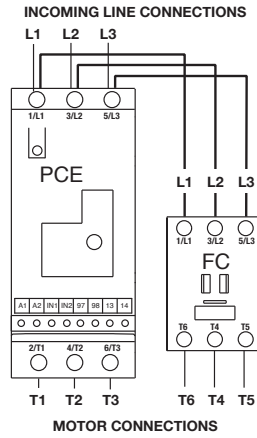
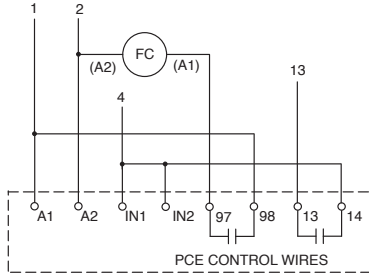

**PCEC 32...147A**

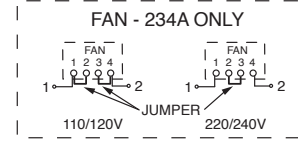
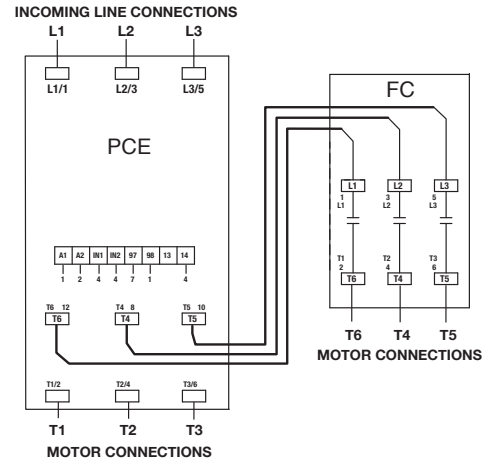

**PCEC 234A**

**PCEC Hydraulic Elevator Softstarters**

**DELTA Connection Diagrams, Power, and Motor Wiring**

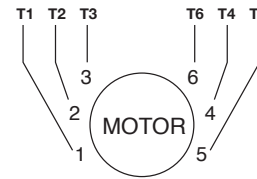
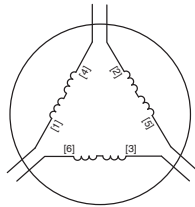
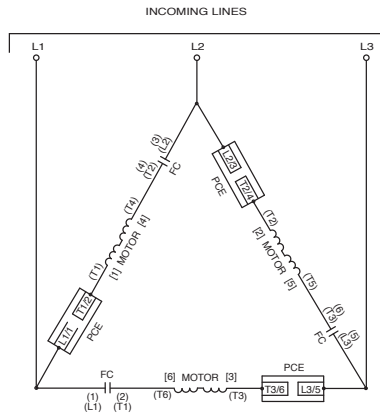

6 LEAD MOTOR CONNECTIONS							
STARTER TERMINALS	T1	T2	T3	T6	T4	T5	JUMPER
MOTOR TERMINALS	1	2	3	6	4	5	N/A

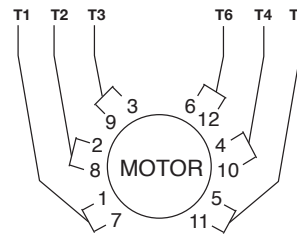
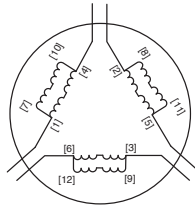
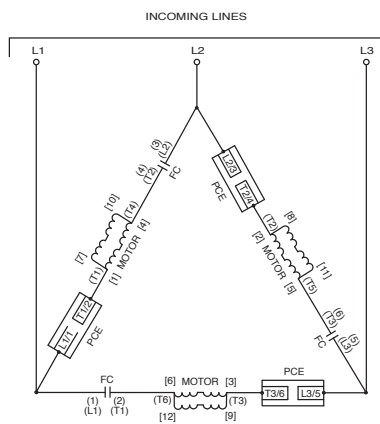

12 LEAD 230V LOW VOLTAGE MOTOR CONNECTIONS							
STARTER TERMINALS	T1	T2	T3	T6	T4	T5	JUMPER
MOTOR TERMINALS	1&7	2&8	3&9	6&12	4&10	5&11	N/A

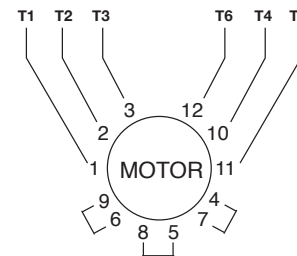
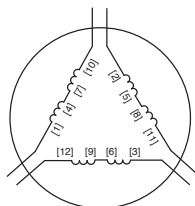
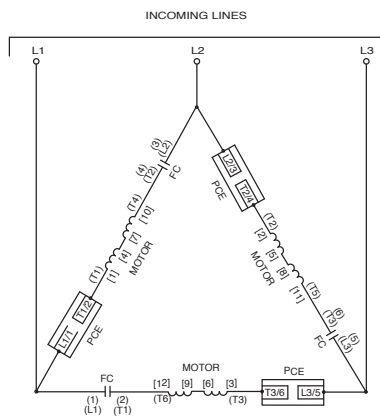

12 LEAD 460V HIGH VOLTAGE MOTOR CONNECTIONS							
STARTER TERMINALS	T1	T2	T3	T6	T4	T5	JUMPER
MOTOR TERMINALS	1	2	3	12	10	11	4&7 5&8 6&9

**D** PCEC Hydraulic Elevator Softstarters

**LINE Connection Diagrams, Power, and Motor Wiring**

- 1- CONTROL POWER (L)
- 2- CONTROL COMMON (N)
- 4- START ENABLE
- 13- UP TO SPEED INDICATION

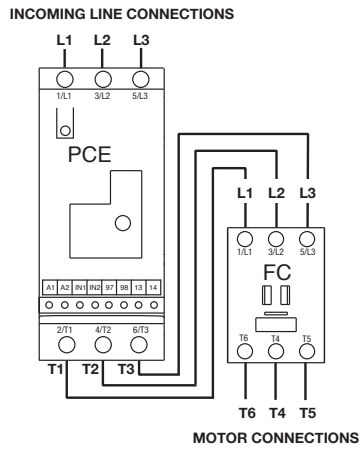
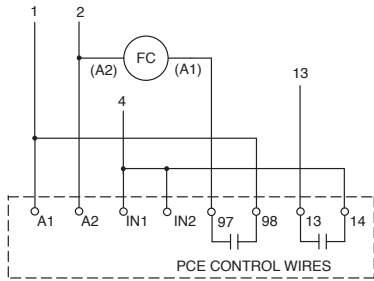

**PCEC 32...147A**

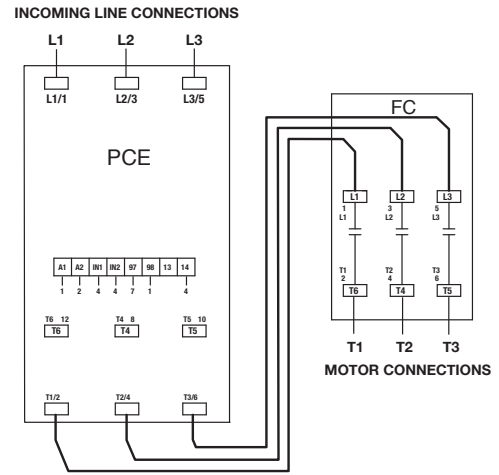

**PCEC 234A**

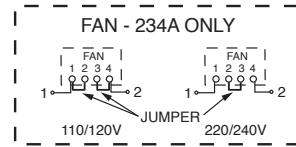

Note: The power wire configuration and DIP switch settings must be changed for the Line Connection method.

**PCEC Hydraulic Elevator Softstarters**

**D**

### LINE Connection Diagrams, Power, and Motor Wiring

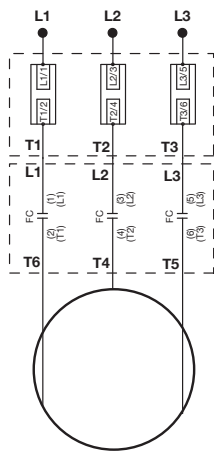

WYE

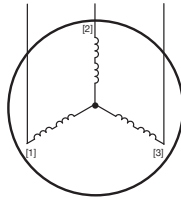

DELTA

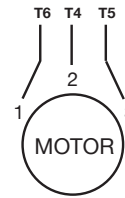
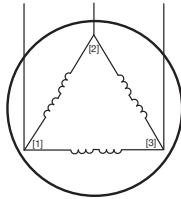

3 LEAD MOTOR CONNECTIONS

STARTER TERMINALS	T6	T4	T5	JUMPER
WYE & DELTA MOTOR TERMINALS	1	2	3	N/A

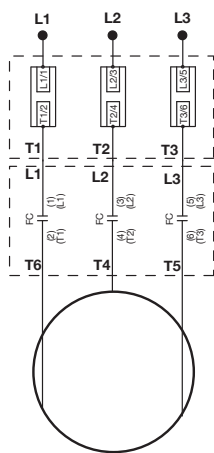

WYE

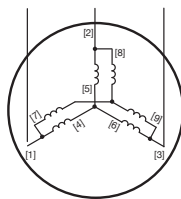

DELTA

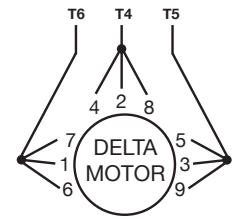
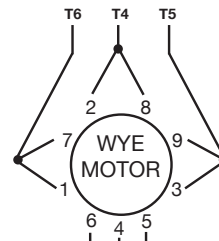
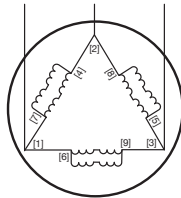

9 LEAD, 230V LOW VOLTAGE, MOTOR CONNECTIONS

STARTER TERMINALS	T6	T4	T5	JUMPER
WYE MOTOR TERMINALS	1 & 7	2 & 8	3 & 9	4, 5, 6
DELTA MOTOR TERMINALS	1,6,7	2,4,8	3,5,9	N/A

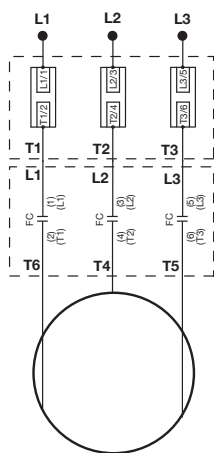

WYE

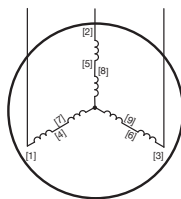

DELTA

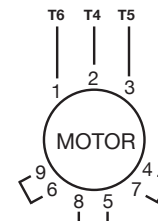
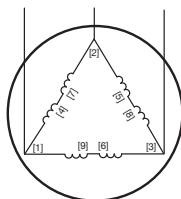

9 LEAD, 460V HIGH VOLTAGE, MOTOR CONNECTIONS

STARTER TERMINALS	T6	T4	T5	JUMPER
WYE & DELTA MOTOR TERMINALS	1	2	3	4 & 7 5 & 8 6 & 9

D PCEC Hydraulic Elevator Softstarters

DELTA Connected Controller - Typical Control Wiring

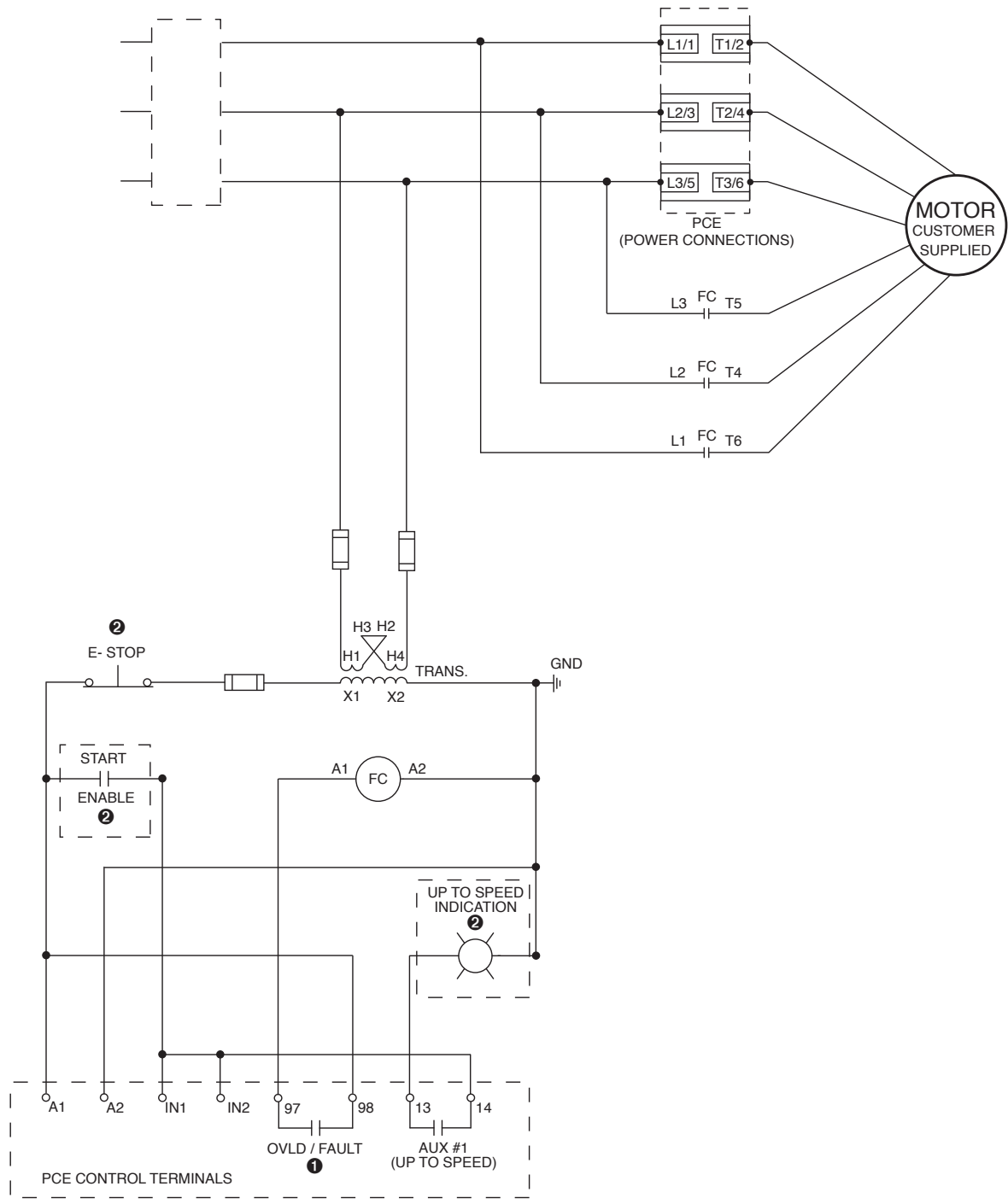

- ❶ When (A1)(A2) control power is applied, (97)(98) contact closes instantaneously and opens when the PCE detects an overload or fault condition, or when control power is removed.
- ❷ Customer supplied.



LINE Connected Controller - Typical Control Wiring

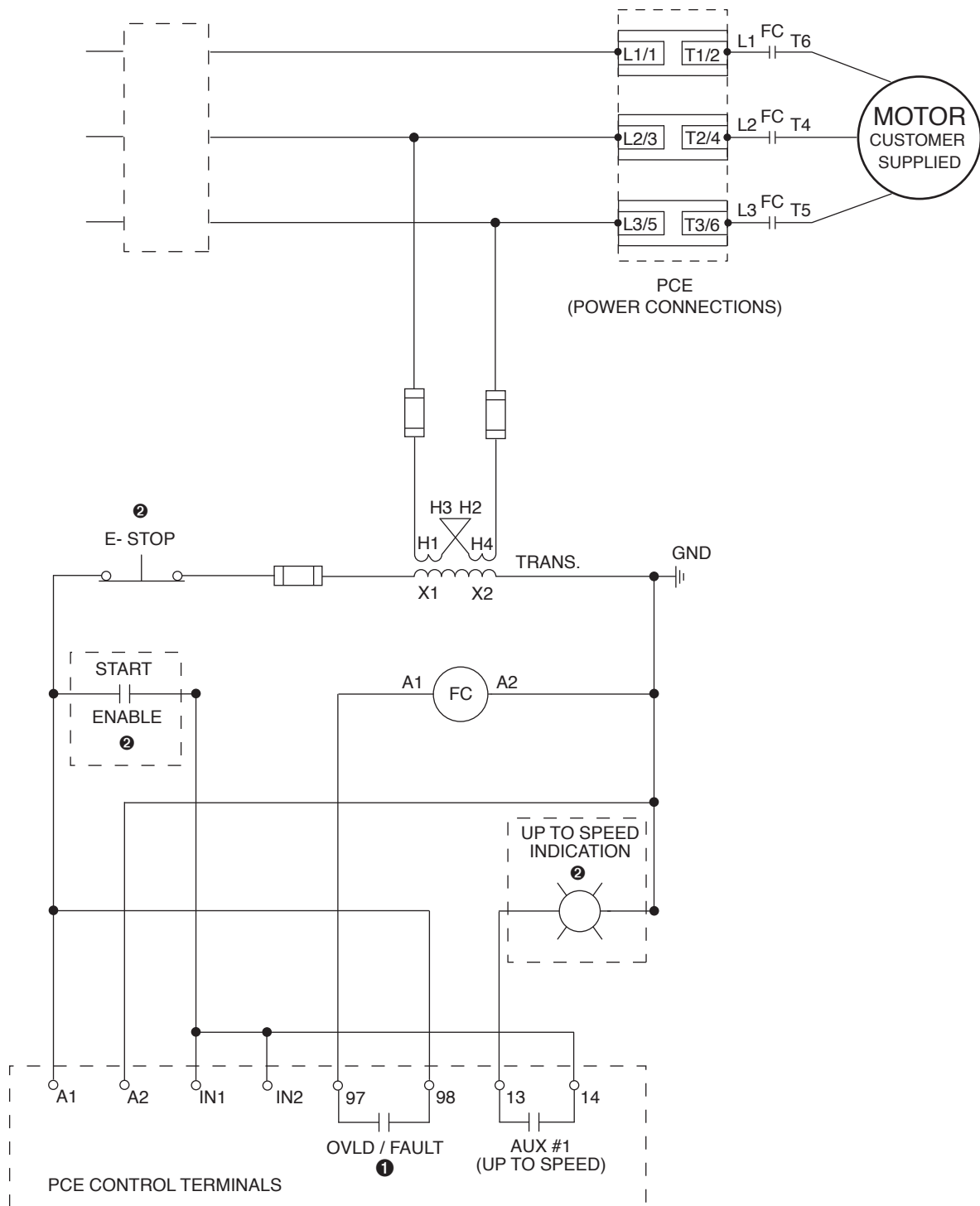

❶ When (A1)(A2) control power is applied, (97)(98) contact closes instantaneously and opens when the PCE detects an overload or fault condition, or when control power is removed.

❷ Customer supplied.

**PCEC Hydraulic Elevator Softstarter**

Dimensions are in millimeters (inches). Dimensions not intended for manufacturing purposes.

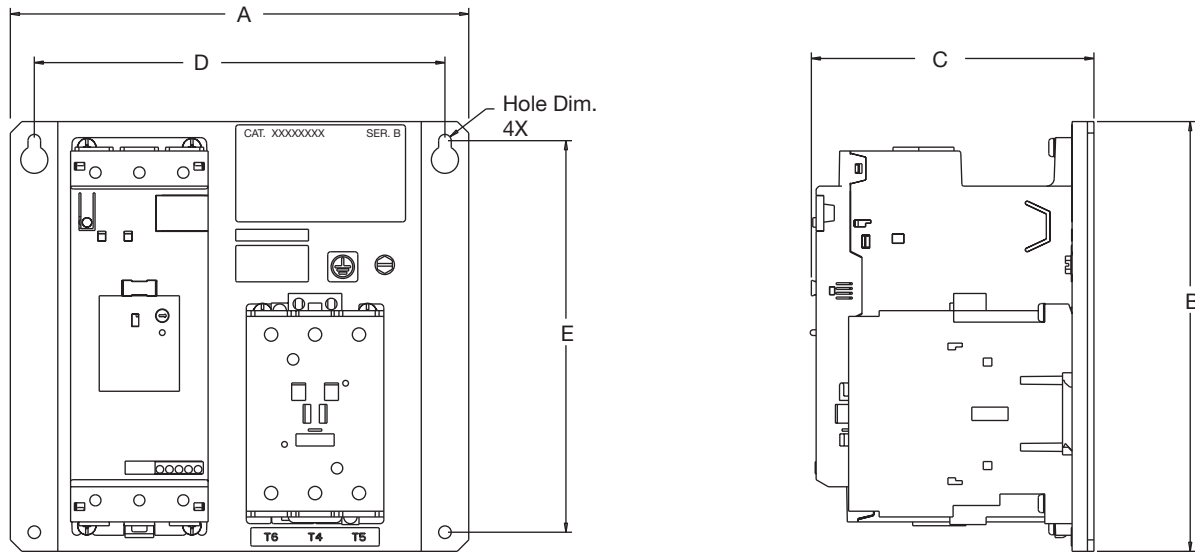

Controller Size	Units	A (Width)	B (Height)	C (Depth)	D	E	Hole Dim - 4x	Approx. Weight
32/51/64	mm	178	144	115.7	165.1	127.0	5.6	4 lbs (2 kg)
	in	7.01	5.67	4.56	6.50	5.00	0.22	
74/104/147	mm	240	225	147.9	215	205	6.6	14 lbs (6 kg)
	in	9.45	8.86	5.82	8.46	8.07	0.260	
234	mm	362	515	216.4	330.2	489.5	8.7	51 lbs (23 kg)
	in	14.25	20.28	8.52	13.00	19.27	0.343	

**D** PCEC Hydraulic Elevator Softstarters