

# NEMA Starters for HVAC/R

## NEMA-Sized Starters For Heavy Duty Commercial & Industrial Applications

The Sprecher + Schuh HVAC/R Program is designed to simplify the selection of starters for HVAC/R market opportunities. Sprecher + Schuh through-the-door combination starters for HVAC/R applications provide an alternative to flange-operated combination starters that are economical without sacrificing quality or robustness. For years, Sprecher + Schuh has built standard custom control panels for these applications to meet rigid consultant specifications and to comply with UL and NEC requirements.

### NEMA Sized for all HVAC/R applications

Sprecher + Schuh offers a complete line of combination and non-combination starters suitable for almost any HVAC/R application in the industry. Standard HVAC/R starters range from NEMA Size 00 up to NEMA size 3 (50HP @460V AC).

Standard starters include Non-combination, Fusible, Non-Fusible and Molded Case Circuit Breaker disconnects. All sizes are available in metallic Type 1 General Purpose or Type 3R Outdoor Rain tight enclosures. Three-phase and Single-Phase styles are available. An additional factory assembled option is the fireman damper interface, especially designed for meeting the needs of building and contractor specifications for shut down control.



**C**  
NEMA Starters



Fractional Manual Starters



KWIKstarters

### HVAC/R Program Features

- Fractional Manual Starters for easy, simple starting to 1 HP
- KWIKstarters for a quick solution, built from stock and easily assembled
- Robust, quality core components and accessories
- Multiple disconnect options in a wide range of sizes
- Wide range of choices to fit a variety of building automation needs

### Customized for You

Almost all HVAC/R focused products can be customized to fit the exact needs of your building automation project. From simple starting of roof-top compressors and ventilation fans, to complete pump panel solutions for industrial chillers, we've got you covered.



Non-combination Starter



Fusible Combination Starter



Fireman Damper Options

# Fractional Manual Starters

Easy, simple starting of Motors up to 1 HP

Sprecher + Schuh Fractional Manual Starters (FMS) consist of a snap switch combined with a thermal overload device operating on the solder-ratchet principle. To reset the overload mechanism, the switch lever is moved to the OFF position. The motor can be restarted by simply pushing the switch lever to the ON position. The switch is designed to prevent being held closed under a sustained motor overload.

## Easy to Order

FMS Starters are easy to order. Simply choose a 1-Pole or 2-Pole with or without the Neon pilot light and then order the required Heater Element. You're done!

## Typical Applications

Starting and overload protection of small 1-phase 115...230V AC/DC or 277 VAC motors used on the following applications:

- Unit heaters
- Fans
- Stokers
- Pumps
- Refrigeration compressors

NEMA Starters



### Fractional Manual Starter

	Ratings (HP)		Poles ②	Type 1 General Purpose Surface Mounting Catalog Number
	115...230V AC	277V AC		
	Toggle Switch Only			
	1	1	1-Pole	FMS-TAX4
	1	1	2-Pole	FMS-TAX5
	Toggle Switch with Neon Pilot Light (115 or 230V)			
1	1	1-Pole	FMS-TAX216	
1	1	2-Pole	FMS-TAX109	

### Heater Element (Required) ①

Full Load Amps	Catalog Number
0.17	P1
0.21	P2
0.25	P3
0.32	P4
0.39	P5
0.46	P6
0.57	P7
0.71	P8
0.79	P9
0.87	P10
0.98	P11
1.08	P12
1.19	P13
1.30	P14
1.43	P15
1.58	P16
1.75	P17
1.88	P18
2.13	P19
2.40	P20
2.58	P21
2.92	P22
3.09	P23
3.32	P24
3.37	P25
4.16	P26
4.51	P27
4.93	P28
5.43	P29
6.03	P30
6.83	P31
7.72	P32
8.24	P33
8.90	P34
9.60	P35
10.8	P36
12.0	P37
13.5	P38
15.2	P39

### Optional Locking Attachment

	Accessory	Catalog Number
	<b>Locking Attachment</b> For locking toggle switch in ON or OFF position.	FMS-N1

### Selecting Heater Elements ③

The "Full Load Amps" listed in the table can be used for heater element selection. The rating of the relay in amperes at 40°C is 115% of the "Full Load Amps" (FLA) listed for the catalog number. Refer to the motor nameplate for the full load current, the service factor, and/or the motor classification by application and temperature rise. Use this motor nameplate information, the application rules and the FLA listed in the table to determine the Heater Element catalog number for motors rated for Continuous Duty.

1. *For the Same Temperature at the Controller and Motor* : Select the Heater Element with the listed FLA nearest the full load value shown on the motor nameplate.
2. *For Higher Temperature at the Controller than at the Motor* : If the full load current value shown on the motor nameplate is between the listed FLAs, select the Heater Element with the next higher value.
3. *For a Lower Temperature at the Controller than at the Motor* : If the full load current value shown on the motor nameplate is between the listed FLAs, select the Heater Element with the next lower value.
4. *All other motors rated for continuous duty* (includes motors with marked service factor 1.0): Select the Heater Element one rating smaller than determined by rules in 1, 2 and 3.

### Ordering Instructions

Order FMS Catalog Number
Order Required FMS Heater Element(s) ①
Order Optional FMS Locking Attachment

- ① One heater is required for 1-pole or 2-pole applications. See schematic on next page.
- ② Two-pole selections are applicable for 3/4 HP at 115...230V DC.
- ③ Rule 2 and 3 temperature difference not to exceed more than 10°C (18°F).

C101.2

Discount Schedule B7 (PGC 14U, 97T, 341)

### Technical Information

#### Eutectic Operation

Thermal overload devices using the eutectic alloy method are spring loaded in the normal, or reset, position. When the heater is cold, the solder is solid and holding the spring loaded ratchet. When FLA is passed through the heater, and if excess current flows, then the solder will melt and allow the ratchet mechanism to turn. This result trips the device. The device is reset by turning the switch to the OFF position and allowing it to cool.

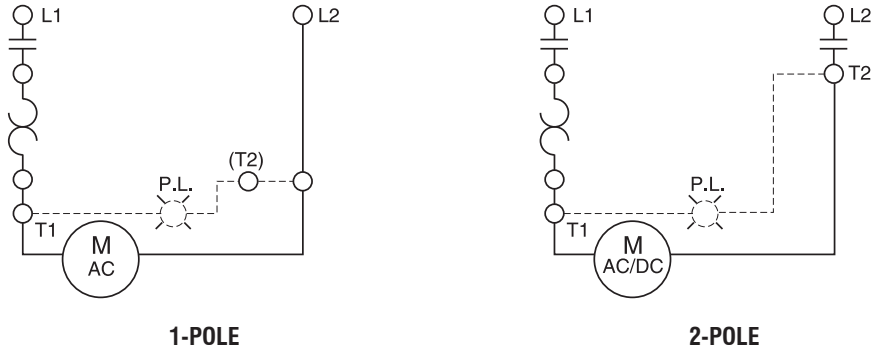

#### Standards Compliance

- UL 508
- EN60947-4-1
- CSA C22.2, No. 14

#### Certifications

- UL Listed - Enclosed Products (File No. E14841; Guide No. NLRV)
- CSA Certified (File No. LR 1234)
- American Bureau of Shipping (ABS)
- CE marked

#### Trip Time

- Class 20
- Reset Time: The actual time to reset will vary based on the ambient temperature surrounding the overload. Under most conditions, it will take from approximately 90 seconds up to 5 minutes for the solder to solidify enough for the overload to be reset. Until this happens, the overload will not be able to be reset by pressing on the reset button. The ratchet assembly inside the overload block will spin freely until the solder has solidified.

### Dimensions

#### FMS Type 1 General Purpose Surface Mounting

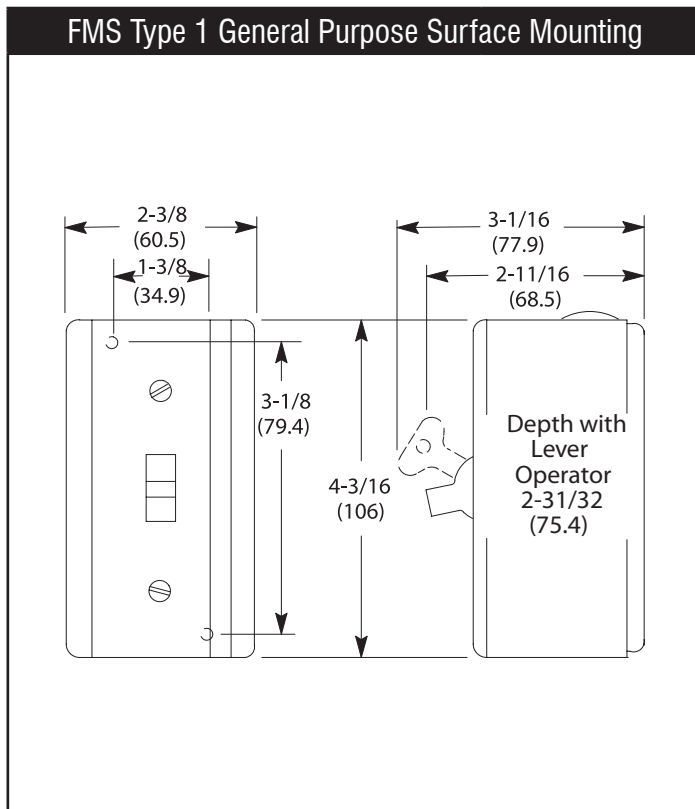

#### TIME - Current Characteristics at 40°C

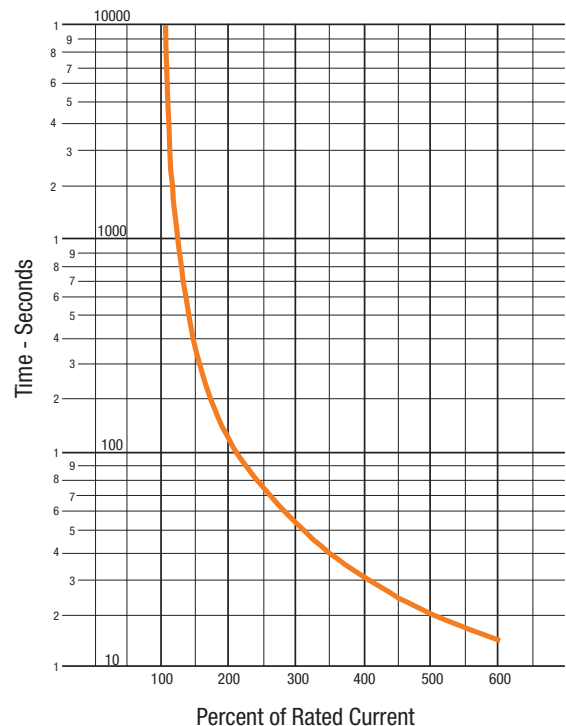

NOTE: Trip will occur at 115% of FLA

# NEMA Labeled KWIKstarters

Preassembled or build from stock – Easy, fast, economical enclosed starters for applications up to 30HP



Most KWIKstarters are equipped with Thermal Overload protection as standard

Sprecher + Schuh offers a broad selection of pre-assembled or “build-from-stock” starters housed in a high impact, non-metallic, cUL Approved, Type 1, 12, 4, 4X enclosure. Built for convenience, space savings and economy, KWIKstarters are efficiently designed to use stock CA7 contactors and CEP7 or CT7N overloads usually stocked by distributors. Contactor and overload are either pre-wired and pre-mounted onto the enclosure’s built-in DIN-rail or may be ordered as separate components. Ample knockouts and open terminals guarantee quick, no fuss wiring.

## Sized for most industrial applications

KWIKstarters control motors up to 30HP @ 460V in two sizes of enclosures, measuring only 208 x 98mm (7.4” x 3.9”) or 250 x 125mm (9.85” x 4.93”) for our larger sizes. This covers over 85% of industrial motor control applications in a very compact package that can be mounted adjacent to or directly on equipment.

## Thermal overload protection

KWIKstarters, sized 9 to 23 amps, are equipped with Sprecher + Schuh’s CT7N bimetallic thermal overload relay as standard. The consistent high quality of our thermal overload relays is ensured by a complex current calibration procedure performed after each unit is at full operating temperature.

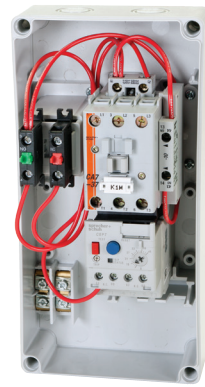

KWIKstarters are also available with our advanced CEP7 Solid State Overload Relay (select appropriate overload relay code for this option)

## Solid state overload options

KWIKstarters, sizes 9 to 23 amps, can also be supplied with Sprecher + Schuh’s CEP7 solid state overload relay. The CEP7 Overload is standard on larger (sizes 30 to 43 amps) and all reversing KWIKstarters. The CEP7 solid state overload relays measure motor current directly through integrated current transformers and on board electronics. The electronics provide increased accuracy and numerous other advantages over electromechanical relays. Learn more about Sprecher + Schuh overload relays in Section B of this catalog.

## Build it yourself...

KWIKstarters may be assembled from stock components. Just grab a CA7 contactor and overload of your choice and snap them into the enclosure. Minimal wiring is required and assembly can be completed in minutes.





Start-Stop or Reset only

Hand-Off-Auto with Pilot Light

Multi-Function

Forward-Stop-Reverse options

#### NEMA KWIKstarters with CEP7 Overload Relays ①

Cover Control/ Enclosure (KS7-COS1/COS4)	NEMA Size	Maximum Horsepower						Total Aux. Contacts Installed		cUL Approved- Type 1/12/4/4X IP66	D I M
		Single Ø		Three Ø				NO	NC		
		115V	230V	200V	230V	460V	575V				
	<b>KWIKstarter with Start &amp; Raised Stop with AC Coil ④⑤</b>										
	00	.33	1	~	~	~	~	1 ②	0	CBKN7-12-*-◆-P2 CAKN7-12-*-◆-P2	Q1
	0	1	2	~	~	~	~	1 ②	0	CBKN7-16-*-◆-P2 CAKN7-16-*-◆-P2	Q1
	~	~	~	3	3	5	5				
	<b>KWIKstarter with Start &amp; Raised Stop with Electronic DC Coil ⑥</b>										
	00	.33	1	~	~	~	~	1 ②	0	CBKN7-12E-*-◆-P2 CAKN7-12E-*-◆-P2	Q1
	0	1	2	~	~	~	~	1 ②	0	CBKN7-16E-*-◆-P2 CAKN7-16E-*-◆-P2	Q1
	~	~	~	3	3	5	5				
	<b>KWIKstarter with Reset with AC Coil</b>										
	00	.33	1	~	~	~	~	1 ②	0	CBKN7-12-*-◆-P0 CAKN7-12-*-◆-P0	Q1
	0	1	2	~	~	~	~	1 ②	0	CBKN7-16-*-◆-P0 CAKN7-16-*-◆-P0	Q1
	~	~	~	3	3	5	5				
	<b>KWIKstarter with Reset with Electronic DC Coil ⑥</b>										
	00	.33	1	~	~	~	~	1 ②	0	CBKN7-12E-*-◆-P0 CAKN7-12E-*-◆-P0	Q1
	0	1	2	~	~	~	~	1 ②	0	CBKN7-16E-*-◆-P0 CAKN7-16E-*-◆-P0	Q1
	~	~	~	3	3	5	5				

#### Coil Codes ⑤⑥

A.C. Coil Code	Voltage Range		Control Source	
	50 Hz	60 Hz	CBK7	CAK7
24Z	24V	24V	Separate	Separate
120	110V	120V	Common	Separate
220W	200-220V	208-240V	Common	Common
277	240V	277V	Common	~
415	400-415V	~	~	Common
480	440V	480V	~	Common
600	550V	600V	~	Common
D.C. Coil Code	Voltage Range			
	VDC			
12E	12V			
24E	24V			

#### Control Circuit Note

**Common:** Coils are assumed to be common with the line voltage and will be connected to the line source (L1-L2) per the table.

**Separate:** Coils are assumed to be from a separate source and will not be connected to the line source per the table.

#### Ordering Instructions

Specify Catalog Number	
Replace (*) with Coil Code	<b>See this page See page C101.14</b>
Replace (◆) with O/L Relay	
<b>Important Note:</b> KWIKstarters are only designed to accommodate CEP7 Solid State Overload Relays. Select O/L Relay Code from page C101.14.	

① KWIKstarters are designed for three-wire control circuits. Two-wire (maintain) control can be accomplished by adding pushbutton latch KS7-PLA.

② A special design NO auxiliary contact (Cat.# KS7-PCK) is used as the holding circuit interlock, as well as, the START button interface. It is not available for other use.

③ Refer to page C101.17 for dimensional information.

④ STOP button also functions as RESET button. Plastic Bezel is standard.

⑤ Other voltages available, see Section A.

⑥ CAN7-12E...16E with electronic coils are not interchangeable with non-electronic DC or AC coils.

#### NEMA KWIKstarters with CEP7 Overload Relays with H-O-A and Light ①②③⑤

Cover Control/ Enclosure (KS7-COS1)	NEMA Size	Maximum Horsepower						Total Aux. Contacts Installed		cUL Approved- Type 1/12/4/4X IP66	D I M
		Single Ø		Three Ø				NO	NC		
		115V	230V	200V	230V	460V	575V			Catalog Number	
<b>NEMA KWIKstarter with Reset and H-O-A Selector Switch and Light with AC Coil</b>											
00	.33	1	~	~	~	~	1 ⑤	0	CBKN7-12-*-◆-P0+1R7	Q1	
	~	~	1.5	1.5	2	2			CAKN7-12-*-◆-P0+1R7		
0	1	2	~	~	~	~	1 ⑤	0	CBKN7-16-*-◆-P0+1R7	Q1	
	~	~	3	3	5	5			CAKN7-16-*-◆-P0+1R7		
<b>NEMA KWIKstarter with Reset and H-O-A Selector Switch and Light with Electronic DC Coil ⑥</b>											
00	.33	1	~	~	~	~	1 ⑤	0	CBKN7-12E-*-◆-P0+1R7	Q1	
	~	~	1.5	1.5	2	2			CAKN7-12E-*-◆-P0+1R7		
0	1	2	~	~	~	~	1 ⑤	0	CBKN7-16E-*-◆-P0+1R7	Q1	
	~	~	3	3	5	5			CAKN7-16E-*-◆-P0+1R7		



NEMA Starters

#### Coil Codes ⑥

A.C. Coil Code	Voltage Range		Control Source	
	50 Hz	60 Hz	CBK7	CAK7
24Z	24V	24V	Separate	Separate
120	110V	120V	Common	Separate
220W	200V-220V	208V-240V	Common	Common
D.C. Coil Code	Voltage Range			
	VDC			
12E	12V			
24E	24V			

#### Control Circuit Note

**Common:** Coils and pilot devices in the control circuit are assumed to be common with the line voltage and will be connected to the line source (L1-L2) per the table.



**Separate:** Coils and pilot devices in the control circuit are assumed to be from a separate source and will not be connected to the line source per the table. Line Voltage not listed: (i.e.: 480 and 575 VAC) require a separate control source (i.e.: 120 VAC). D7D pilot devices are rated 300 VAC maximum.

#### Ordering Instructions

Specify Catalog Number	
Replace (*) with Coil Code Replace (◆) with O/L Relay	<b>See this page See page C101.14</b>
<b>Important Note:</b> KWIKstarters are only designed to accommodate CEP7 Solid State Overload Relays. Select O/L Relay Code from page C101.14.	

- ① This is a factory assembly. The KS7-COS1 (Q1) enclosure does not include knock-outs for field assembly of this starter.
- ② Uses D7D-P4N\_ Red Monolithic "Run" pilot light with LED bulb. Pilot light voltage to match coil voltage for 24, 120, 240 VAC control. Red "Run" Light can be changed for Green. Change +1R7 to +1G7. For example, CAKN7-12-\*-◆-P0+1R7 becomes CAKN7-12-\*-◆-P0+1G7.
- ③ Uses D7D-SM32x20 Monolithic 3-position selector switch for maintain control, HAND-OFF-AUTO function with legend plate.
- ④ Refer to page C101.10 for wiring and C101.17 for dimensional information. This is a clam-shell enclosure design with wires to cover controls.
- ⑤ One NO auxiliary for customer use. There is no room for additional auxiliaries.
- ⑥ CAN7-12E...16E with electronic coils are not interchangeable with non-electronic DC or AC coils.

#### NEMA KWIKstarters with CEP7 Overload Relays ❶

Enclosure (KS7-C2S4)	NEMA Size	Maximum Horsepower						Total Aux. Contacts Installed		cUL Approved-Type 1/12/4/4X IP66	DIM
		Single Ø		Three Ø				NO	NC		
		115V	230V	200V	230V	460V	575V				
<b>NEMA KWIKstarters with AC Coil</b>											
	1	2	3	~	~	~	~	1	0	CBKN7-37-*-*♦-P▼ CAKN7-37-*-*♦-P▼	Q2
		~	~	7.5	7.5	10	10				
	2	3	7.5	~	~	~	~	1	0	CBKN7-43-*-*♦-P▼ CAKN7-43-*-*♦-P▼	Q2
		~	~	10	15	25	25				
<b>NEMA KWIKstarters with Electronic DC Coil ❷</b>											
	1	3	5	~	~	~	~	1	0	CBKN7-37E-*-*♦-P▼ CAKN7-37E-*-*♦-P▼	Q2
		~	~	7.5	7.5	10	10				
	2	3	7.5	~	~	~	~	1	0	CBKN7-43E-*-*♦-P▼ CAKN7-43E-*-*♦-P▼	Q2
		~	~	10	15	25	25				

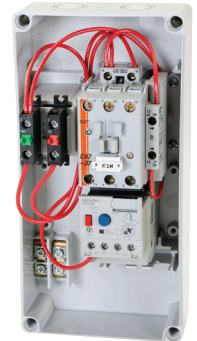

**NEMA Starters**

#### Coil Codes (\*) ❸❹❺

A.C. Coil Code	Voltage Range		Control Source	
	50 Hz	60 Hz	CBK7	CAK7
24Z	24V	24V	Separate	Separate
120	110V	120V	Common	Separate
220W	200-220V	208-240V	Common	Common
277	240V	277V	Common	~
415	400-415V	~	~	Common
480	440V	480V	~	Common
600	550V	600V	~	Common

D.C. Coil Code	Voltage Range
	VDC
12E	12V
24E	24V
48E	48-72V
220E	220-250V

#### AC Control Circuit Note

**Common:** Coils and pilot devices in the control circuit are assumed to be common with the line voltage and will be connected to the line source (L1-L2) per the table.

**Separate:** Coils and pilot devices in the control circuit are assumed to be from a separate source and will not be connected to the line source per the table. Pilot lights are 240 VAC maximum.

#### Replace ♦ with one of the following Overload Relays

For use with KWIKstarter...	Amp Range	Overload Relay Code (♦)	Catalog Number (of Overload Relay used)
<b>1-Phase &amp; 3-Phase / Manual Reset / Class 10 or 20</b>			
CAK7-30...43	5.4...27	1EED	CEP7-1EEED
	11...55	1EFD	CEP7-1EEFD
<b>1-Phase &amp; 3-Phase / Auto or Manual Reset / Class 10, 15, 20, 30 ❸</b>			
CAK7-30...43	5.4...27	FED	CEP7-1EFED
	11...55	FFD	CEP7-1EFFD

#### Pilot Device Options (includes reset) ❹❺

Pushbutton Description	Replace ▼ in catalog number with
START-STOP Multi-function (shown)	3U
I-O Multi-function	4U
OFF-ON 2-Position Selector switch	6
Pilot Light Red (LED) with START-STOP Multi-function ❸	1R3U
Pilot Light Red (LED) with I-O Multi-function ❸	1R4U

#### Optional CA7 Modifications (Factory Assembled) ❻

Description	Add to end of catalog number
Electronic Interface	-JE
Surge Suppressor RD	-C
Surge Suppressor Varistor	-V
Additional NC Contact	-L01
Additional NO Contact	-L10



#### Ordering Instructions

Specify Catalog Number	
Replace (*) with Coil Code	<b>See this page only</b>
Replace (♦) with O/L Relay	
Replace (▼) with Pilot Device Option	

- ❶ Use CEP7-1 overloads only - and also backward compatible to CEP7-ED1/EE.
- ❷ Plastic Bezel is standard. Pilot Device options include D7-BX\_ Base Mounted contact blocks. See page H69 for more information.
- ❸ Refer to page C101.15 for wiring diagram and C101.17 for dimensional information.
- ❹ CAN7-37E...43E with electronic coils are not interchangeable with non-electronic DC or AC coils.

- ❺ Other voltages available, see Section A.
- ❻ One and only one Pilot Device option must be selected. If Pilot Light option is selected then coil voltage must be 24V AC or DC, 120V or 240V AC only.
- ❼ CPT not possible with KS7-C2S4 (Q2) enclosure.
- ❽ List price adder may apply for this option.

### Three Phase Reversing NEMA KWIKstarters with CEP7 Overload Relays ①③

Enclosure (KS7-C0S4R)	NEMA Size	Maximum Horsepower				Total Aux. Contacts Installed		cUL Approved-Type 1/12/4/4X IP66	DIM
		Three Ø				NO	NC		
		200V	230V	460V	575V				
<b>3-Phase FVR NEMA KWIKstarter with AC Coil</b>									
	00	1.5	1.5	2	2	1	1	CAUKN7-12-♦-P▼	Q3
	0	3	3	5	5	1	1	CAUKN7-16-♦-P▼	Q3
<b>3-Phase FVR NEMA KWIKstarter with Electronic DC Coil</b>									
	00	1.5	1.5	2	2	1	1	CAUKN7-12E-♦-P▼	Q3
	0	3	3	5	5	1	1	CAUKN7-16E-♦-P▼	Q3



### Coil Codes (\*) ④⑤⑦

A.C. Coil Code	Voltage Range		Control Source		D.C. Coil Code	Voltage Range
	50 Hz	60 Hz	CBK7	CAK7		VDC
24Z	24V	24V	Separate	Separate	12E	12V
120	110V	120V	Common	Separate	24E	24V
220W	200-220V	208-240V	Common	Common	36E	36-48V
277	240V	277V	Common	~	48E	48-72V
415	400-415V	~	~	Common	110E	110-125V
480	440V	480V	~	Common	220E	220-250V
600	550V	600V	~	Common		

### AC Control Circuit Note

**Common:** Coils and pilot devices in the control circuit are assumed to be common with the line voltage and will be connected to the line source (L1-L2) per the table.

**Separate:** Coils and pilot devices in the control circuit are assumed to be from a separate source and will not be connected to the line source per the table. Pilot lights are 240 VAC maximum.

### Pilot Device Options (includes reset) ②③

Pushbutton Description	Replace ▼ in catalog number with
FOR-STOP-REV Multi-function (shown)	3U
UP-STOP-DOWN Multi-function	4U
OPEN-STOP-CLOSE Multi-function	5U
FOR-STOP-REV 3-Position Selector switch	6
UP-OFF-DOWN 3-Position Selector switch	7
OPEN-OFF-CLOSE 3-Position Selector switch	8
Overload Alarm Pilot Light	1Y
D7-N8 22mm Hole Plug	0

### Optional CA7 Modifications (Factory Assembled) ④

Description (supplied on each contactor)	Add to end of catalog number
Electronic Interface	-2JE
Surge Suppressor RD	-2C
Surge Suppressor Varistor	-2V

### Ordering Instructions

Specify Catalog Number	
Replace (*) with Coil Code	See this page only
Replace (♦) with O/L Relay	
Replace (▼) with Pilot Device Option	

### Replace ♦ with one of the following Overload Relays

For use with KWIKstarter...	Amp Range	Overload Relay Code (♦)	Catalog Number (of Overload Relay used)
<b>1-Phase &amp; 3-Phase / Manual Reset / Class 10 or 20</b>			
CAUKN7-12..16 CAUKN7-12E..16E	0.1...0.5	1EAB	CEP7-1EEAB
	0.2...1.0	1EBB	CEP7-1EEBB
	1.0...5.0	1ECB	CEP7-1EECB
	3.2...16	1EDB	CEP7-1EEDB
	5.4...27	1EEB	CEP7-1EEEB
<b>1-Phase &amp; 3-Phase / Auto or Manual Reset / Class 10, 15, 20, 30 ⑤</b>			
CAUKN7-12..16 CAUKN7-12E..16E	0.1...0.5	FAB	CEP7-1EFAB
	0.2...1.0	FBB	CEP7-1EFBB
	1.0...5.0	FCB	CEP7-1EFGB
	3.2...16	FDB	CEP7-1EFDB
	5.4...27	FEB	CEP7-1EFEB

- Use CEP7-ED/CEP7-EE overloads only.
- Plastic Bezel is standard. Pilot Device options include D7-BX\_ Base Mounted contact blocks. See page H69 for more information.
- Refer to page C101.16 for wiring diagram and C101.17 for dimensional information.
- CAN7-12E...16E with electronic coils are not interchangeable with non-electronic DC or AC coils.
- Other voltages available, see Section A.
- One Pilot Device option must be selected. Blanks are not available. If Pilot Light option is selected then Pilot Light must match Coil Voltage 24V AC or DC, 120V or 240V AC only.
- CPT not possible with KS7-C0S4R (Q3) enclosure.
- One N.C. auxiliary contact is used for electrical interlocking. On CAUKN7 reversing starters, the N.C. contact comes from the Mechanical/Electrical Interlock unit (Cat# CM7-02).
- List price adder may apply for this option.



#### Three Phase, Non-Reversing CAKN7 @ 200V AC KWIKstarter

NEMA Size	Max HP 3 Ø	Adjustment Range	Start-Stop Pushbutton or Multi- function with Reset	Reset Only	D I M ⑥
			Catalog Number	Catalog Number	
00	0.5	1.0...5.0	CAKN7-12-220W-1ECB-P2 ① ② ③	CAKN7-12-220W-1ECB-PO ① ②	Q1
	0.75	1.0...5.0	CAKN7-12-220W-1ECB-P2 ① ② ③	CAKN7-12-220W-1ECB-PO ① ②	
	1	3.2...16	CAKN7-12-220W-1EDB-P2 ① ② ③	CAKN7-12-220W-1EDB-PO ① ②	
	1.5	3.2...16	CAKN7-12-220W-1EDB-P2 ① ② ③	CAKN7-12-220W-1EDB-PO ① ②	
0	2	3.2...16	CAKN7-16-220W-1EDB-P2 ① ② ③	CAKN7-16-220W-1EDB-PO ① ②	Q1
	3	3.2...16	CAKN7-16-220W-1EDB-P2 ① ② ③	CAKN7-16-220W-1EDB-PO ① ②	
1	5	5.4...27	CAKN7-37-220W-1EED-P3U ④ ⑤		Q2
	7.5	11...55	CAKN7-37-220W-1EFD-P3U ④ ⑤		
2	10	11...55	CAKN7-43-220W-1EFD-P3U ④ ⑤		



CAK7-12...16 Amp  
(Q1 Dim – Start/Stop)



CAK7-12...16 Amp  
(Q1 Dim - Reset) Only



CAK7-37...43 Amp  
(Q2 Dim)

NEMA Starters

#### Three Phase, Non-Reversing CAKN7 @ 230V AC KWIKstarter

NEMA Size	Max HP 3 Ø	Adjustment Range	Start-Stop Pushbutton or Multi- function with Reset	Reset Only	D I M ⑥
			Catalog Number	Catalog Number	
00	0.5	1.0...5.0	CAKN7-12-220W-1ECB-P2 ① ② ③	CAKN7-12-220W-1ECB-PO ① ②	Q1
	0.75	1.0...5.0	CAKN7-12-220W-1ECB-P2 ① ② ③	CAKN7-12-220W-1ECB-PO ① ②	
	1	1.0...5.0	CAKN7-12-220W-1ECB-P2 ① ② ③	CAKN7-12-220W-1ECB-PO ① ②	
	1.5	3.2...16	CAKN7-12-220W-1EDB-P2 ① ② ③	CAKN7-12-220W-1EDB-PO ① ②	
0	2	3.2...16	CAKN7-16-220W-1EDB-P2 ① ② ③	CAKN7-16-220W-1EDB-PO ① ②	Q1
	3	3.2...16	CAKN7-16-220W-1EDB-P2 ① ② ③	CAKN7-16-220W-1EDB-PO ① ②	
1	5	5.4...27	CAKN7-37-220W-1EED-P3U ④ ⑤		Q2
	7.5	5.4...27	CAKN7-37-220W-1EED-P3U ④ ⑤		
2	10	11...55	CAKN7-43-220W-1EFD-P3U ④ ⑤		Q2
	15	11...55	CAKN7-43-220W-1EFD-P3U ④ ⑤		

#### Full Voltage Non-Reversing (FVNR)

##### Features include:

- NEMA-sized CAN7 contactor
- CEP7 Solid State Overload Relay (Q1/Q2 Dim)
- Green Start pushbutton (Q1 Dim – Start/Stop)
- Red Raise Stop pushbutton (Q1 Dim – Start/Stop)
- Reset pushbutton (Q1 Dim – Reset)
- 1-NO auxiliary for customer use
- Non-Metallic Enclosure Type 1/12/4/4X, IP66
- Pre-wired for easy installation
- Ideal for compressors, fans, blowers

#### Three Phase, Non-Reversing CAKN7 @ 480V AC KWIKstarter

NEMA Size	Max HP 3 Ø	Adjustment Range	Start-Stop Pushbutton or Multi- function with Reset	Reset Only	D I M ⑥
			Catalog Number	Catalog Number	
00	0.5	1.0...5.0	CAKN7-12-480-1ECB-P2 ① ② ③	CAKN7-12-480-1ECB-PO ① ②	Q1
	0.75	1.0...5.0	CAKN7-12-480-1ECB-P2 ① ② ③	CAKN7-12-480-1ECB-PO ① ②	
	1	1.0...5.0	CAKN7-12-480-1ECB-P2 ① ② ③	CAKN7-12-480-1ECB-PO ① ②	
	1.5	1.0...5.0	CAKN7-12-480-1ECB-P2 ① ② ③	CAKN7-12-480-1ECB-PO ① ②	
	2	1.0...5.0	CAKN7-12-480-1ECB-P2 ① ② ③	CAKN7-12-480-1ECB-PO ① ②	
0	3	3.2...16	CAKN7-16-480-1EDB-P2 ① ② ③	CAKN7-16-480-1EDB-PO ① ②	Q1
	5	3.2...16	CAKN7-16-480-1EDB-P2 ① ② ③	CAKN7-16-480-1EDB-PO ① ②	
1	7.5	5.4...27	CAKN7-37-480-1EED-P3U ④ ⑤		Q2
	10	5.4...27	CAKN7-37-480-1EED-P3U ④ ⑤		
2	15	11...55	CAKN7-43-480-1EFD-P3U ④ ⑤		Q2
	20	11...55	CAKN7-43-480-1EFD-P3U ④ ⑤		
	25	11...55	CAKN7-43-480-1EFD-P3U ④ ⑤		

- ① KWIKstarters are designed for three-wire control circuits. Two-wire (maintain) control can be accomplished by adding pushbutton latch KS7-PLA.
- ② A special design NO auxiliary contact (Cat.# KS7-PCK) is used as the holding circuit interlock, as well as, the START button interface. It is not available for other use.
- ③ STOP button also functions as RESET button. Plastic bezel is standard.
- ④ Use CEP7-1 overloads only - and also backward compatible to CEP7-ED1/EE.
- ⑤ Plastic bezel is standard. Pilot device options include D7-BX\_ base Mounted contact blocks. See page H69 for more information.
- ⑥ Refer to page C100.18 for dimensional information

#### Single Phase, Non-Reversing CBKN7 @ 115V AC KWIKstarter ❶

NEMA Size	Max HP 1 Ø	Adjustment Range	Start-Stop Pushbutton or Multi- function with Reset	Reset Only	D I M
			❷❸❹		
115V			Catalog Number	Catalog Number	❺
00	0.25	3.2...16	CBKN7-12-120-1EDB-P2 ❸	CBKN7-12-120-1EDB-P0 ❸	Q1
	0.33	3.2...16	CBKN7-12-120-1EDB-P2 ❸	CBKN7-12-120-1EDB-P0 ❸	
0	0.5	3.2...16	CBKN7-16-120-1EDB-P2 ❸	CBKN7-16-120-1EDB-P0 ❸	
	0.75	3.2...16	CBKN7-16-120-1EDB-P2 ❸	CBKN7-16-120-1EDB-P0 ❸	
	1	5.4...27	CBKN7-16-120-1EEB-P2 ❸	CBKN7-16-120-1EEB-P0 ❸	
1	1.5	5.4...27	CBKN7-37-120-1EED-P3U ❷❹		Q2
	2	11...55	CBKN7-37-120-1EFD-P3U ❷❹		
2	3	11...55	CBKN7-43-120-1EFD-P3U ❷❹		



CBKN7-12...16 Amp



CBKN7-12...16  
Amp Reset Only



CBKN7-37...43 Amp

#### Single Phase, Non-Reversing CBKN7 @ 230V AC KWIKstarter ❶

NEMA Size	Max HP 1 Ø	Adjustment Range	Start-Stop Pushbutton or Multi- function with Reset	Reset Only	D I M
			❷❸❹		
230V			Catalog Number	Catalog Number	❺
00	0.25	1.0...5.0	CBKN7-12-220W-1ECB-P2 ❸	CBKN7-12-220W-1ECB-P0 ❸	Q1
	0.33	1.0...5.0	CBKN7-12-220W-1ECB-P2 ❸	CBKN7-12-220W-1ECB-P0 ❸	
	0.5	3.2...16	CBKN7-12-220W-1EDB-P2 ❸	CBKN7-12-220W-1EDB-P0 ❸	
	0.75	3.2...16	CBKN7-12-220W-1EDB-P2 ❸	CBKN7-12-220W-1EDB-P0 ❸	
	1	3.2...16	CBKN7-12-220W-1EDB-P2 ❸	CBKN7-12-220W-1EDB-P0 ❸	
0	1.5	3.2...16	CBKN7-16-220W-1EDB-P2 ❸	CBKN7-16-220W-1EDB-P0 ❸	Q1
	2	3.2...16	CBKN7-16-220W-1EDB-P2 ❸	CBKN7-16-220W-1EDB-P0 ❸	
1	3	5.4...27	CBKN7-37-220W-1EED-P3U ❷❹		Q2
2	5	11...55	CBKN7-43-220W-1EFD-P3U ❷❹		
	7.5	11...55	CBKN7-43-220W-1EFD-P3U ❷❹		

#### Full Voltage Non-Reversing (FVNR)

##### Features include:

- NEMA-sized CAN7 contactor
- CEP7 Solid State Overload Relay
- Green Start pushbutton
- Red Raise Stop pushbutton
- Reset pushbutton
- 1-NO auxiliary for customer use
- Non-Metallic Enclosure Type 1/12/4/4X, IP66
- Pre-wired for easy installation
- Ideal for compressors, fans, blowers

❶ KWIKstarters are designed for three-wire control circuits. Two-wire (maintain) control can be accomplished by adding pushbutton latch KS7-PLA.

❷ A special design NO auxiliary contact (Cat.# KS7-PCK) is used as the holding circuit interlock, as well as, the START button interface. It is not available for other use.

❸ Refer to page C101.15 for wiring diagram and C101.17 for dimensional information.

❹ STOP button also functions as RESET button. Plastic Bezel is standard.

❺ Other voltages available, see Section A.

❻ Use CEP7-1 overloads only - and also backward compatible to CEP7-ED1/EE.

❼ Plastic Bezel is standard. Pilot Device options include D7-BX\_ Base Mounted contact blocks. See page H69 for more information.

❽ CPT not possible with KS7-C2S4 (Q2) enclosure.

#### Three Phase, Non-Reversing CAKN7 @ 200V AC KWIKstarter ①②③⑤

NEMA Size	Max HP	Adjustment Range	with CT7N Overload Relay	D I M
	3 0		Catalog Number	
00	0.5	1.0...5.0	CAKN7-12-220W-1ECB-P0+1R7	Q1
	0.75	1.0...5.0	CAKN7-12-220W-1ECB-P0+1R7	
	1	3.2...16	CAKN7-12-220W-1EDB-P0+1R7	
	1.5	3.2...16	CAKN7-12-220W-1EDB-P0+1R7	
0	2	3.2...16	CAKN7-16-220W-1EDB-P0+1R7	Q1
	3	3.2...16	CAKN7-16-220W-1EDB-P0+1R7	

#### Three Phase, Non-Reversing CAKN7 @ 230V AC KWIKstarter ①②③⑤

NEMA Size	Max HP	Adjustment Range	with CEP7 Overload Relay	D I M
	3 0		Catalog Number	
00	0.5	1.0...5.0	CAKN7-12-220W-1ECB-P0+1R7	Q1
	0.75	1.0...5.0	CAKN7-12-220W-1ECB-P0+1R7	
	1	1.0...5.0	CAKN7-12-220W-1ECB-P0+1R7	
	1.5	3.2...16	CAKN7-12-220W-1EDB-P0+1R7	
0	2	3.2...16	CAKN7-16-220W-1EDB-P0+1R7	Q1
	3	3.2...16	CAKN7-16-220W-1EDB-P0+1R7	

#### Single Phase, Non-Reversing CBKN7 @ 115V AC KWIKstarter ①②③⑤

NEMA Size	Max HP	Adjustment Range	with CEP7 Overload Relay	D I M
	3 0		Catalog Number	
00	0.25	3.2...16	CBKN7-12-120-1EDB-P0+1R7	Q1
	0.33	3.2...16	CBKN7-12-120-1EDB-P0+1R7	
	0.5	3.2...16	CBKN7-16-120-1EDB-P0+1R7	
0	0.75	3.2...16	CBKN7-16-120-1EDB-P0+1R7	Q1
	1	5.4...27	CBKN7-16-120-1EEB-P0+1R7	

#### Single Phase, Non-Reversing CBKN7 @ 230V AC KWIKstarter ①②③⑤

NEMA Size	Max HP	Adjustment Range	with CEP7 Overload Relay	D I M
	3 0		Catalog Number	
00	0.25	1.0...5.0	CBKN7-12-220W-1ECB-P0+1R7	Q1
	0.33	1.0...5.0	CBKN7-12-220W-1ECB-P0+1R7	
	0.5	3.2...16	CBKN7-12-220W-1EDB-P0+1R7	
	0.75	3.2...16	CBKN7-12-220W-1EDB-P0+1R7	
	1	3.2...16	CBKN7-12-220W-1EDB-P0+1R7	
0	1.5	3.2...16	CBKN7-16-220W-1EDB-P0+1R7	Q1
	2	3.2...16	CBKN7-16-220W-1EDB-P0+1R7	



#### Full Voltage Non-Reversing (FVNR)

##### Features include:



- NEMA-sized CAN7 contactor
- CEP7 Solid State Overload Relay
- Red Pilot Light
- Hand-Off-Auto Selector Switch
- Reset pushbutton
- 1-NO auxiliary for customer use
- Non-Metallic Enclosure Type 1/12/4/4X, IP66
- Pre-wired for easy installation
- Ideal for compressors, fans, blowers

C



NEMA Starters

- ① This is a factory assembly. The KS7-C0S1 (Q1) enclosure does not include knock-outs for field assembly of this starter.
- ② Uses D7D-P4N\_ Red Monolithic "Run" pilot light with LED bulb. Pilot light voltage to match coil voltage for 24, 120, 240 VAC control. Red "Run" Light can be changed for Green. Change +1R7 to +1G7. For example, CAKN7-12-★-◆-P0+1R7 becomes CAKN7-12-★-◆-P0+1G7.
- ③ Uses D7D-SM32x20 Monolithic 3-position selector switch for maintain control, HAND-OFF-AUTO function with legend plate.
- ④ Refer to page C101.10 for wiring and C101.17 for dimensional information. This is a clam-shell enclosure design with wires to cover controls.
- ⑤ One NO auxiliary for customer use. There is no room for additional auxiliaries.

**KWIKstarter 9...23A Enclosures with CEP7 Overload Relays ①**

Component	Description	For Use With		Environmental Approvals	Catalog Number
		Contactors	Overload		
	<b>Flush Green START / Extended Red STOP</b> - Mechanical interface auxiliary contact (KS7-PCK) included in enclosure.	CA7-9...23	CEP7-1__D ⑤	cUL Type 1/12/4/4x IEC IP66	<b>KS7-C0S4</b>
	<b>Blue RESET Only</b>	CA7-9...23	CEP7-1__B ⑤	cUL Type 1/12/4/4x IEC IP66	<b>KS7-C0S1</b>

**KWIKstarter Enclosures for use with CA7 Contactors and Overload Relays ①④**

Component	Description	For Use With		Environmental Approvals	Catalog Number
		Contactors	Overload		
	<b>Enclosure for KWIKstarter ②</b> CAK7/CBK7-30...43 CAK7/CBK7-30E...43E	CA7-30...43 CA7-30E...43E	CEP7-1__D ⑤	cUL Type 1/12/4/4x IEC IP66	<b>KS7-C2S4</b>
	<b>Enclosure for Reversing KWIKstarter ③</b> CAUK7-9...23 CAUK7-9E...23E	CAU7-9...23 CAU7-9E...23E	CEP7-1__B ⑤	cUL Type 1/12/4/4x IEC IP66	<b>KS7-C0S4R</b>

① KWIKstarters are only designed to accommodate CA7-9...43 contactors with CEP7 Solid State Overload Relays. If ordering components, select contactor from Section A and overload relay from Section B in this catalog.



② KWIKstarter enclosure KS7-C2S4 are designed to fit CA7-30(E)...43(E) contactors with CEP7 Overload Relays. CT7N Thermal Overloads can not be substituted.

③ KWIKstarter enclosure KS7-C0S4R are designed to fit CAU7-9(E)...23(E) reversing contactors with CEP7 Overload Relays. CT7N Thermal Overloads can not be substituted.

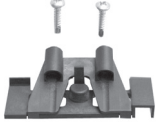

④ KS7-C2S4 and KS7-C0S4R are supplied with two 22mm holes for Pilot Devices. A Reset is required and one additional pilot device kit from page C101.13 must be selected. Use of a CPT is not possible.

⑤ KS7-C\_ series B enclosure are compatible to 3rd gen CEP7-1 and 2nd gen CEP7-ED1/EE. KS7-C\_ series A enclosures (obsolete) are compatible to 2nd gen CEP7-ED1/EE.

**KWIKstarter Components with CT7N or CEP7 Overload Relays (for use with KS7-COS1/KS7-COS4)**

Component	Description	For Use With...	Catalog Number
	<b>Start - Contact kit</b> Specially designed NO auxiliary; mechanically interfaces with the START button. Mounts on right side. A KS7-PCK is included in every KS7-COS4 enclosure.	KS7-COS4 (Replacement Part)	<b>KS7-PCK</b>
	<b>Pushbutton Latch -</b> For maintain contact control (2-wire control)	KS7-COS4	<b>KS7-PLA</b>
	<b>Neutral Terminal</b>	KS7-COS1 KS7-COS4	<b>KS7-PNT</b>
	<b>Grounding Kit</b> (for use with metal conduit)	All KWIKstarter enclosures	<b>KS7-GR1</b>

**KWIKstarter Pilot Device Kits (for use with KS7-C2S4/KS7-COS4R) ①**

Kits	Description	For Use With Enclosure...	Contact Blocks included		Catalog Number
			NO	NC	
	<b>Multi-Function Pushbutton kit</b> Non-illuminated <b>START-STOP</b> <b>I-O</b>	KS7-C2S4 Type 1, 12, 4, 4X	1	1	<b>KS7-P3U</b> <b>KS7-P4U</b>
	<b>FOR-STOP-REV</b> <b>UP-STOP-DOWN</b> <b>OPEN-STOP-CLOSE</b>	KS7-COS4R Type 1, 12, 4, 4X	2	1	<b>KS7-P3U-REV</b> <b>KS7-P4U-REV</b> <b>KS7-P5U-REV</b>
	<b>Selector switch kits</b> Non-illuminated, includes legend plate <b>ON-OFF</b> 2-Position	KS7-C2S4 Type 1, 12, 4, 4X	1	-	<b>KS7-P6</b>
	<b>FOR-OFF-REV</b> 3-Position <b>UP-OFF-DOWN</b> 3-Position <b>OPEN-OFF-CLOSE</b> 3-Position	KS7-COS4R Type 1, 12, 4, 4X	2	-	<b>KS7-P6-REV</b> <b>KS7-P7-REV</b> <b>KS7-P8-REV</b>
	<b>Reset Pushbutton, Blue</b> Plastic push button, flush operator with Blue Cap and R text	KS7-C2S4 KS7-COS4	Black Plastic with Blue Cap and White "R"		<b>D7P-F611</b> ②

① Plastic bezel is standard. Pilot Device Kits include D7-BX\_ Base Mounted contact blocks. See page H69 for more information.

② D7P-R611 and CEP7-1ERA can not be used with KS7-C2S4 or KS7-COS4R. See Section H for more information.

**KWIKstarters with CEP7 Solid State Overload Relay ①**

For use with KWIKstarter...	Amp Range	Overload Relay Code (◆)	Catalog Number (of Overload Relay used)
<b>1-Phase &amp; 3-Phase / Manual Reset / Class 10 or 20</b>			
CAUK7-9...23 CAUK7-9E...23E	0.1...0.5	<b>1EAB</b>	CEP7-1EEAB
	0.2...1.0	<b>1EBB</b>	CEP7-1EEBB
	1.0...5.0	<b>1ECB</b>	CEP7-1EECB
	3.2...16	<b>1EDB</b>	CEP7-1EEDB
	5.4...27	<b>1EEB</b>	CEP7-1EEEB
<b>1-Phase &amp; 3-Phase / Auto or Manual Reset / Class 10...30</b>			
CAUK7-9...23 CAUK7-9E...23E	0.1...0.5	<b>FAB</b>	CEP7-1EFAB
	0.2...1.0	<b>FBB</b>	CEP7-1EFBB
	1.0...5.0	<b>FCB</b>	CEP7-1EFGB
	3.2...16	<b>FDB</b>	CEP7-1EFDB
	5.4...27	<b>FEB</b>	CEP7-1EFEB

**NEMA Starters**

① CEP7 Overloads are available for use in KWIKStarters if the premium features are required (see Section B).

## KWIKstarter (in enclosure KS7-COS1/COS4)

CUSTOMER MUST PROVIDE PROPER BRANCH CIRCUIT PROTECTION (F1)  
SEE THE APPLICATION INSTRUCTION SHEET - COMPONENT SELECTION TABLES  
FOR MAX. FUSE SIZE & CLASS AND APPLICABLE SHORT CIRCUIT RATING  
(USE 75°C COPPER WIRE ONLY)

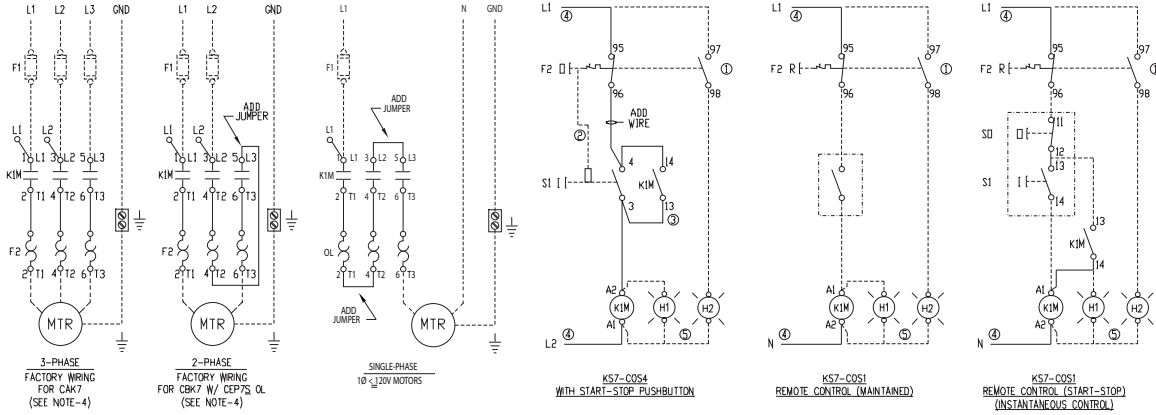

THIS DRAWING IS FOR THE FOLLOWING ENCLOSURES:  
KS7-COS4 with integrated START-STOP push button  
KS7-COS1 with integrated RESET push button

### NOTES:

- 1) MECHANICAL LATCH KS7-PLA FOR MAINTAINED CONTROL (OPTIONAL).
- 2) START CONTACT KIT KS7-PCK (INCLUDED) MOUNTS ON THE RIGHT SIDE WITH MOLDED PRE-FORMED JUMPERS.
- 3) DO NOT WIRE CONTROLS CIRCUIT TO LINE SIDE OF CONTACTOR WHEN COIL VOLTAGE IS 120V OR LESS. (FACTORY WIRING STANDARD)
- 4) OPTIONAL PILOT LIGHTS.

## KWIKstarter (in enclosure KS7-C2S4)

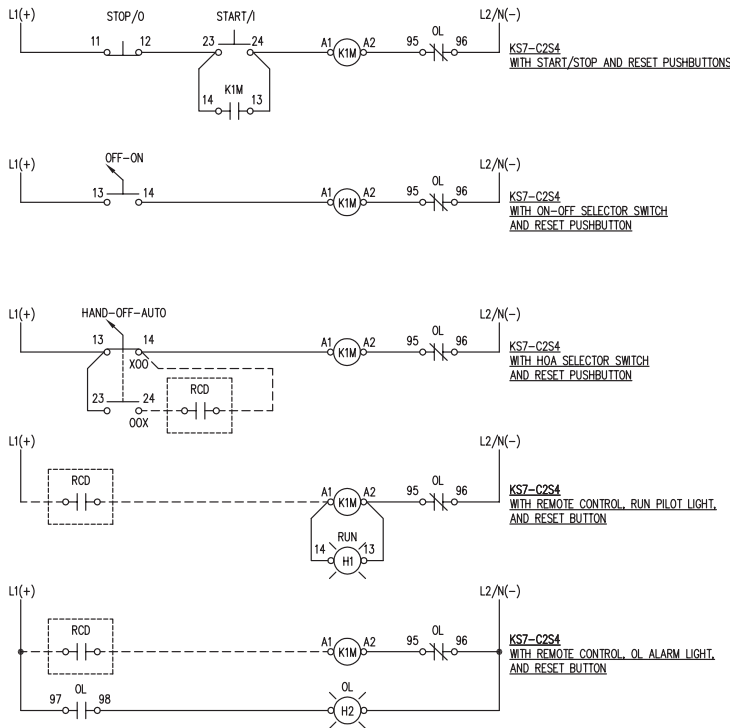

CUSTOMER WILL PROVIDE BRANCH CIRCUIT PROTECTION (F1)  
SEE THE APPLICATION INSTRUCTION SHEET - COMPONENT SELECTION TABLES  
FOR MAX. FUSE SIZE, CLASS, AND APPLICABLE SHORT CIRCUIT RATING  
(USE 75°C COPPER WIRE ONLY)

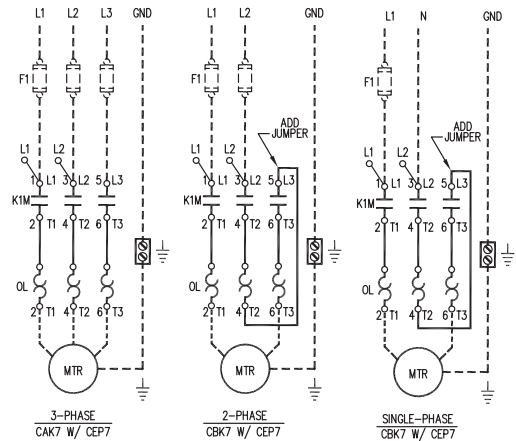

### NOTES:

1. DO NOT CONNECT A1-A2 TO L1-L2 UNLESS COIL VOLTAGE MATCHES LINE VOLTAGE
2. PILOT LIGHTS POSSIBLE FOR REMOTE OR OVERLOAD ALARM IF NO START/STOP CONTROL DEVICES IN COVER
3. RCD = REMOTE CONTROL DEVICE (BY OTHERS)

### Reversing KWIKstarter (in enclosure KS7-C0S4R)

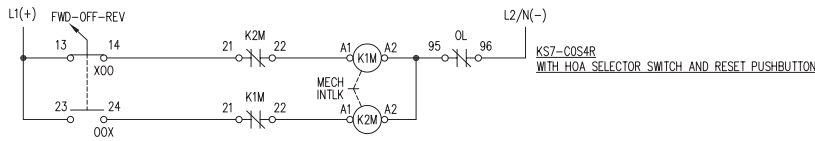
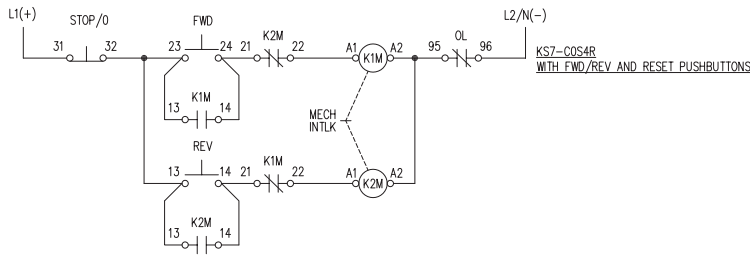

NOTE:  
DO NOT CONNECT A1-A2 TO L1-L2 UNLESS COIL VOLTAGE MATCHES LINE VOLTAGE

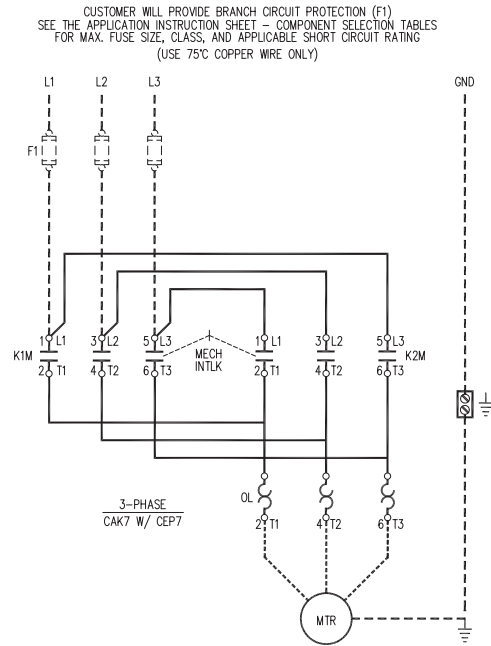

### KWIKstarter (in enclosure KS7-C0S1) with HOA option

HAND-OFF-AUTO with  
Pilot Light

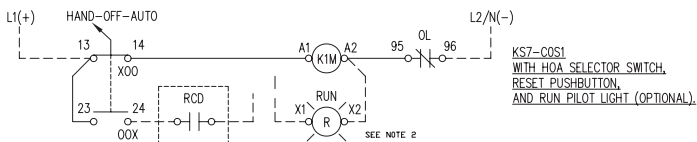
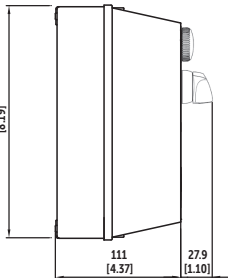

CUSTOMER WILL PROVIDE BRANCH CIRCUIT PROTECTION (F1)  
SEE THE APPLICATION INSTRUCTION SHEET - COMPONENT SELECTION TABLES  
FOR MAX. FUSE SIZE, CLASS, AND APPLICABLE SHORT CIRCUIT RATING  
(USE 75°C COPPER WIRE ONLY)

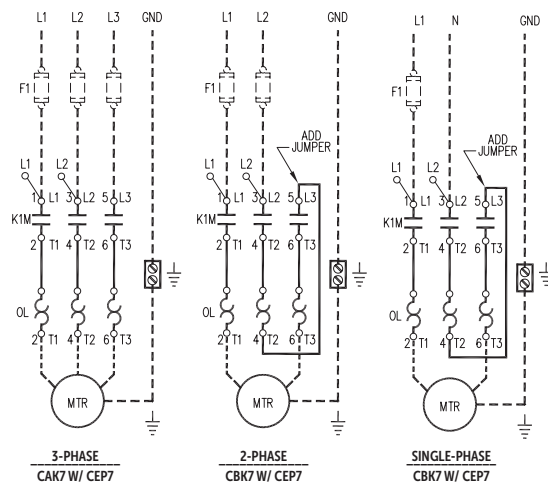

NOTES:

- RCD = REMOTE CONTROL DEVICE (BY OTHERS). WIRE RCD TO TERMINAL 24 ON THE H-O-A SEL. SW. AND TERMINAL A1 ON THE CONTACTOR.
- DASHED LINES - - - - - INDICATE WIRING PROVIDED IN THE FIELD.

A.C. Coil Code	Voltage Range		Control Source	
	50 Hz	60 Hz	CBK7	CAK7
24Z	24V	24V	Separate	Separate
120	110V	120V	Common	Separate
208	~	208V	Common	Common
220W	200V-220V	208V-240V	Common	Common
240	220V	240V	Common	Common

  

D.C. Coil Code	Voltage Range		Control Source	
	VDC		CBK7	CAK7
12E	12V		Separate	Separate
24E	24V		Separate	Separate



**KWIKstarter Enclosure KS7-C0S1/C0S4 (Dimension Code Q1-Q3)**

Dimensions are in millimeters (inches). Dimensions not intended for manufacturing purposes.

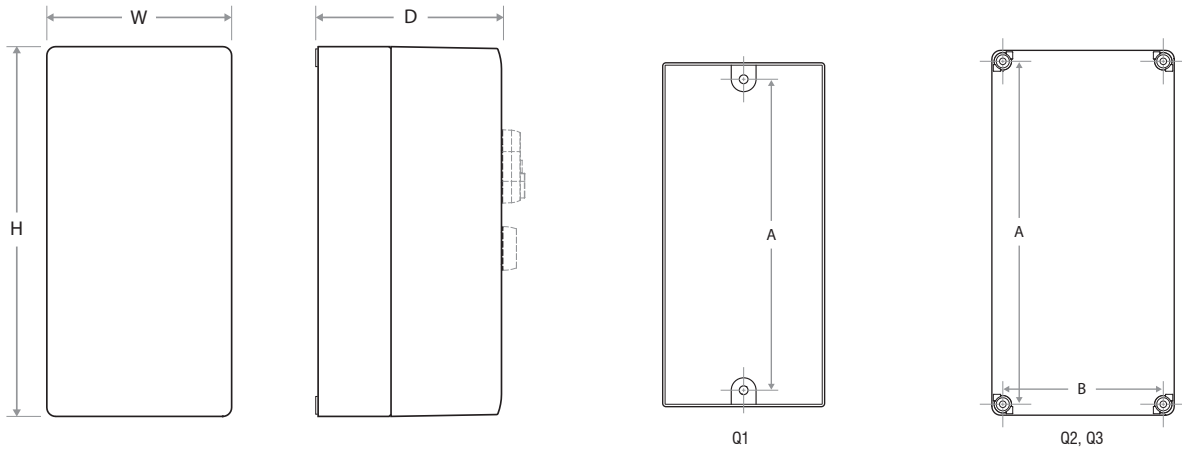

**Enclosure Size**

DIM Code	W	H	D
Q1	97 [3.86]	205 [8.08]	111 [4.37]
Q2, Q3	125 [4.93]	250 [9.85]	125 [4.93]

**Provision for Cable Gland Fittings**

DIM Code	ØTop	ØBack
Q1	2 X 20.3 [0.80] or 25.3 [1.00]	4 X 20.3 [0.80] or 25.3 [1.00]
Q2, Q3	2 X 20.3 [0.80] or 25.3 [1.00]	~

**Mounting**

DIM Code	Mount Type	ØA	ØB	Dia.
Q1	2 Center screws	188 [7.4]	Centered	5.3 [0.2]
Q2, Q3	4 Corner screws	235 [9.26]	110 [4.33]	5.3 [0.2]

# NEMA Sized Open and Enclosed Contactors and Non-Combination Motor Starters

**C**  
NEMA Starters

Built to your specifications and ready to install

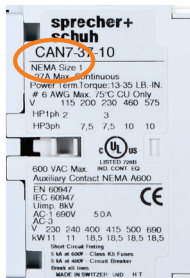
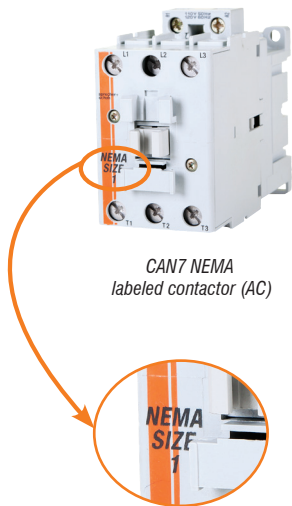

Sprecher + Schuh magnetic motor starters are intended to eliminate the purchase and assembly of a separate contactor, overload relay and associated wiring. When purchased with an enclosure, the starters are mounted and ready to install on receipt.

## Starting with the best

At the heart of all Sprecher + Schuh NEMA sized magnetic motor starters is the CATN7 line of motor starters. Each starter proudly displays the NEMA size (00, 0, 1, 2, or 3) and HP at applied voltage. This line of starters is designed to meet rigid consultant specifications for NEMA starters.

## Top line protection...

NEMA labeled magnetic starters are equipped with Sprecher + Schuh's premium CEP7 solid state overload relay standard. Unlike traditional overload relays that indirectly sense motor current through heater elements, CEP7 solid state overload relays measure motor current directly through integrated current transformers and on board electronics. The electronics provide numerous advantages over electromechanical relays. Alternatively, the CT7N Thermal Overload Relay may also be selected.

## The right enclosure... whatever the application

Sprecher + Schuh's line of NEMA style starters can be purchased pre-installed in a variety of standard enclosures. Cataloged enclosures include:

- |                |                                    |
|----------------|------------------------------------|
| <b>Type 1</b>  | General Purpose                    |
| <b>Type 12</b> | Industrial Dusttight               |
| <b>Type 3R</b> | Raintight (outdoor)                |
| <b>Type 4</b>  | Watertight                         |
| <b>Type 4X</b> | Watertight,<br>Corrosion Resistant |



**Type 1**



**Type 3R**



**Type 4**



**Type 4X**

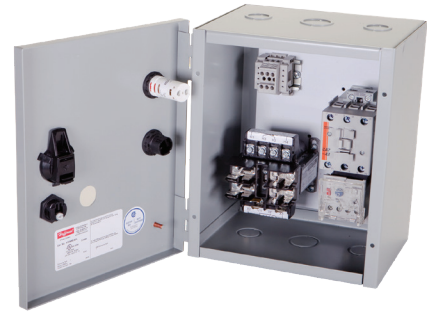

Even though these are the most popular enclosure types for most industrial applications, we can house any starter in a custom enclosure of your choosing.

## Quality enclosures ensure the highest confidence

Sprecher + Schuh only sources enclosures from name brand manufacturers, ensuring the highest quality. We primarily use enclosures that meet UL Standards, i.e., Type 1, Type 3R, etc., however, we can also source other enclosures at your request. Enclosures are sized first to accommodate the depth of the contactor and offer sufficient electrical clearances to satisfy UL.

## Add a variety of modifications

If you need a larger enclosure than what is specified in our catalog, your sales representative and our Engineering department will work with you to customize any of our enclosed products to suit your exact specifications. Any combination of enclosure types, sizes, pilot devices, meters and other modifications can be combined to provide exactly the panel you need.

### Three Phase, Non-Reversing CAN7

NEMA Size	Maximum Horsepower Three Phase				Auxiliary Contacts per Contactor ③		Type 1 General Purpose	D I M	Type 12 [Type 3R ②] Industrial Dusttight	D I M
	200V	230V	460V	575V	NO	NC	Catalog Number	①	Catalog Number	①
00	3	3	7.5	10	1	0	CAN7-12-*-G0	A	CAN7-12-*-D0	L
0	5	5	10	15	1	0	CAN7-16-*-G0	A	CAN7-16-*-D0	L
1	10	10	25	30	1	0	CAN7-37-*-G0	A	CAN7-37-*-D0	L
2	10	15	30	30	1	0	CAN7-43-*-G0	A	CAN7-43-*-D0	L
3	25	30	60	60	1	0	CAN7-85-*-G0	B	CAN7-85-*-D0	M

NEMA Size	Maximum Horsepower Three Phase				Auxiliary Contacts per Contactor ③		Type 4 Watertight	D I M	Type 4X Watertight Corrosion Resistant Non-metallic	D I M
	200V	230V	460V	575V	NO	NC	Catalog Number	①	Catalog Number	①
00	3	3	7.5	10	1	0	CAN7-12-*-W0	N	CAN7-12-*-C0	S1
0	5	5	10	15	1	0	CAN7-16-*-W0	N	CAN7-16-*-C0	S1
1	10	10	25	30	1	0	CAN7-37-*-W0	N	CAN7-37-*-C0	S1
2	10	15	30	30	1	0	CAN7-43-*-W0	N	CAN7-43-*-C0	S1
3	25	30	60	60	1	0	CAN7-85-*-W0	O	CAN7-85-*-C0	U1

**NOTE:** Catalog numbers and enclosure dimensions reflect contactors with AC coils. For DC coils, select Coil Code from the DC Coil Code table on page C104 and follow the instructions for modifying catalog numbers.

### Ordering Instructions

Specify Catalog Number	
Replace (*) with Coil Code Factory Modifications available	<b>Refer to page C104</b> <b>Refer to pages C107-C111</b>

- ① Dimensional information starts on page C122.
- ② For Type 3R outdoor applications, replace "D" in catalog number with an "R". Dimensions may change. For example number CAN7-23-\*-D0 becomes CAN7-23-\*-R0. Price remains the same.
- ③ Contactors are equipped with number and type of auxiliaries indicated. See page C108 to order additional or different auxiliary contacts.

### Three Phase, Reversing CAUN7

NEMA Size	Maximum Horsepower Three Phase				Auxiliary Contacts per Contactor ③		Type 1 General Purpose	DIM ①	Type 12 [Type 3R ②] Industrial Dusttight	DIM ①
	200V	230V	460V	575V	NO	NC ④	Catalog Number		Catalog Number	
00	3	3	7.5	10	1	1	CAUN7-12-*-G0	A	CAUN7-12-*-D0	M
0	5	5	10	15	1	1	CAUN7-16-*-G0	A	CAUN7-16-*-D0	M
1	10	10	25	30	1	1	CAUN7-37-*-G0	A	CAUN7-37-*-D0	M
2	10	15	30	30	1	1	CAUN7-43-*-G0	B	CAUN7-43-*-D0	M
3	25	30	60	60	1	1	CAUN7-85-*-G0	C	CAUN7-85-*-D0	O

NEMA Size	Maximum Horsepower Three Phase				Auxiliary Contacts per Contactor ③		Type 4 Watertight	DIM ①	Type 4X Watertight Corrosion Resistant Non-metallic	DIM ①
	200V	230V	460V	575V	NO	NC ④	Catalog Number		Catalog Number	
00	3	3	7.5	10	1	1	CAUN7-12-*-W0	N	CAUN7-12-*-C0	U1
0	5	5	10	15	1	1	CAUN7-16-*-W0	N	CAUN7-16-*-C0	U1
1	10	10	25	30	1	1	CAUN7-37-*-W0	N	CAUN7-37-*-C0	U1
2	10	15	30	30	1	1	CAUN7-43-*-W0	N	CAUN7-43-*-C0	U1
3	25	30	60	60	1	1	CAUN7-85-*-W0	O	CAUN7-85-*-C0	V1

**NOTE:** Catalog numbers and enclosure dimensions reflect contactors with AC coils. For DC coils, select Coil Code from the DC Coil Code table on page C104 and follow the instructions for modifying catalog numbers.

### Ordering Instructions

Specify Catalog Number	
Replace (*) with Coil Code Factory Modifications available	<b>Refer to page C104</b> <b>Refer to pages C107-C111</b>

- ① Dimensional information starts on page C122.
- ② For Type 3R outdoor applications, replace "D" in catalog number with an "R". Dimensions may change. For example number CAUN7-23-\*-D0 becomes CAUN7-23-\*-R0. Price remains the same.
- ③ Contactors are equipped with number and type of auxiliaries indicated. See page C108 to order additional or different auxiliary contacts.
- ④ One N.C. auxiliary contact is used for electrical interlocking. On CAU7 reversing contactors, the N.C. contact comes from the Mechanical/Electrical Interlock unit (Cat # CM7-02).

### Three Phase, Non-Reversing CATN7

NEMA Size	Maximum Horsepower Three Phase				Aux. Contacts per Contactor ③		Open Type Catalog Number	Type 1 General Purpose Catalog Number	D I M ①	Type 12 [Type 3R ②] Industrial Dusttight Catalog Number	D I M ①
	200V	230V	460V	575V	NO	NC					
00	1.5	1.5	2	2	1	0	CATN7-12-*◆	CATN7-12-*◆-GO	A	CATN7-12-*◆-D0	L
0	3	3	5	5	1	0	CATN7-16-*◆	CATN7-16-*◆-GO	A	CATN7-16-*◆-D0	L
1	7.5	7.5	10	10	1	0	CATN7-37-*◆	CATN7-37-*◆-GO	A	CATN7-37-*◆-D0	L
2	10	15	25	25	1	0	CATN7-43-*◆	CATN7-43-*◆-GO	A	CATN7-43-*◆-D0	L
3	25	30	50	50	1	0	CATN7-85-*◆	CATN7-85-*◆-GO	B	CATN7-85-*◆-D0	M

NEMA Size	Maximum Horsepower Three Phase				Aux. Contacts per Contactor ③		Type 4 Watertight Catalog Number	D I M ①	Type 4X Watertight Corrosion Resistant Non-metallic Catalog Number	D I M ①
	200V	230V	460V	575V	NO	NC				
00	1.5	1.5	2	2	1	0	CATN7-12-*◆-WO	N	CATN7-12-*◆-C0	S1
0	3	3	5	5	1	0	CATN7-16-*◆-WO	N	CATN7-16-*◆-C0	S1
1	7.5	7.5	10	10	1	0	CATN7-37-*◆-WO	N	CATN7-37-*◆-C0	U1
2	10	15	25	25	1	0	CATN7-43-*◆-WO	N	CATN7-43-*◆-C0	U1
3	25	30	50	50	1	0	CATN7-85-*◆-WO	O	CATN7-85-*◆-C0	U1

**NOTE:** Catalog numbers and enclosure dimensions reflect contactors with AC coils. For DC coils, select Coil Code from the DC Coil Code table on page C104 and follow the instructions for modifying catalog numbers.

### Ordering Instructions

Specify Catalog Number	
Replace (*) with Coil Code	See page C104 See pages C105-C106 See pages C107-C111
Replace (◆) with O/L Relay	
Factory Modifications available	

- ① Dimensional information starts on page C122.
- ② For Type 3R outdoor applications, replace "D" in catalog number with an "R". Dimensions may change. For example number CATN7-37-\*◆-D0 becomes CATN7-37-\*◆-R0. Price remains the same.
- ③ Contactors are equipped with number and type of auxiliaries indicated. See page C108 to order additional or different auxiliary contacts.

### Three Phase, Non-Reversing CATN7 @208V AC ②

NEMA Size	Max HP 3-Phase ①	Adjustment Range	Type 1 Metallic General Purpose	D I M	Type 3R Metallic Outdoor Raintight	D I M
			Catalog Number		③ Catalog Number	
00	1.5	0.2...1.0	CATN7-12-XA-1EBB-G17-L11	A	CATN7-12-XA-1EBB-R17-L11	L
	3	1.0...5.0	CATN7-12-XA-1ECB-G17-L11	A	CATN7-12-XA-1ECB-R17-L11	L
	7.5	1.0...5.0	CATN7-12-XA-1ECB-G17-L11	A	CATN7-12-XA-1ECB-R17-L11	L
	10	1.0...5.0	CATN7-12-XA-1ECB-G17-L11	A	CATN7-12-XA-1ECB-R17-L11	L
	25	3.2...16	CATN7-12-XA-1EDB-G17-L11	A	CATN7-12-XA-1EDB-R17-L11	L
0	2	3.2...16	CATN7-16-XA-1EDB-G17-L11	A	CATN7-16-XA-1EDB-R17-L11	L
	3	3.2...16	CATN7-16-XA-1EDB-G17-L11	A	CATN7-16-XA-1EDB-R17-L11	L
1	5	5.4...27	CATN7-37-XA-1EED-G17-L11	A	CATN7-37-XA-1EED-R17-L11	L
	7.5	5.4...27	CATN7-37-XA-1EED-G17-L11	A	CATN7-37-XA-1EED-R17-L11	L
2	10	11...55	CATN7-43-XA-1EFD-G17-L11	A	CATN7-43-XA-1EFD-R17-L11	L
3	15	20...100	CATN7-85-XA-1EGE-G17-L11	B	CATN7-85-XA-1EGE-R17-L11	M
	20	20...100	CATN7-85-XA-1EGE-G17-L11	B	CATN7-85-XA-1EGE-R17-L11	M
	25	20...100	CATN7-85-XA-1EGE-G17-L11	B	CATN7-85-XA-1EGE-R17-L11	M

#### Full Voltage Non-Reversing (FVNR) Features include:

- NEMA-sized CAN7 contactor
- CEP7 Electronic Overload Relay
- Control Circuit Transformer
- Hand-Off-Auto (H-O-A) selector switch
- Red Run pilot light
- 2-NO and 1-NC auxiliaries for customer use
- Class CC Fuse holder as fused primary of CCT
- Reset pushbutton

### Three Phase, Non-Reversing CATN7 @230V AC ②

NEMA Size	Max HP 3-Phase ①	Adjustment Range	Type 1 Metallic General Purpose	D I M	Type 3R Metallic Outdoor Raintight	D I M
			Catalog Number		③ Catalog Number	
00	0.25	0.2...1.0	CATN7-12-XB-1EBB-G17-L11	A	CATN7-12-XB-1EBB-R17-L11	L
	0.5	1.0...5.0	CATN7-12-XB-1ECB-G17-L11	A	CATN7-12-XB-1ECB-R17-L11	L
	0.75	1.0...5.0	CATN7-12-XB-1ECB-G17-L11	A	CATN7-12-XB-1ECB-R17-L11	L
	1	1.0...5.0	CATN7-12-XB-1ECB-G17-L11	A	CATN7-12-XB-1ECB-R17-L11	L
	1.5	1.0...5.0	CATN7-12-XB-1ECB-G17-L11	A	CATN7-12-XB-1ECB-R17-L11	L
0	2	3.2...16	CATN7-16-XB-1EDB-G17-L11	A	CATN7-16-XB-1EDB-R17-L11	L
	3	3.2...16	CATN7-16-XB-1EDB-G17-L11	A	CATN7-16-XB-1EDB-R17-L11	L
1	5	5.4...27	CATN7-37-XB-1EED-G17-L11	A	CATN7-37-XB-1EED-R17-L11	L
	7.5	5.4...27	CATN7-37-XB-1EED-G17-L11	A	CATN7-37-XB-1EED-R17-L11	L
2	10	11...55	CATN7-43-XB-1EFD-G17-L11	A	CATN7-43-XB-1EFD-R17-L11	L
	15	11...55	CATN7-43-XB-1EFD-G17-L11	A	CATN7-43-XB-1EFD-R17-L11	L
3	15	20...100	CATN7-85-XB-1EGE-G17-L11	B	CATN7-85-XB-1EGE-R17-L11	M
	20	20...100	CATN7-85-XB-1EGE-G17-L11	B	CATN7-85-XB-1EGE-R17-L11	M
	25	20...100	CATN7-85-XB-1EGE-G17-L11	B	CATN7-85-XB-1EGE-R17-L11	M

#### Full Voltage Non-Reversing (FVNR) Features include:

- NEMA-sized CAN7 contactor
- CEP7 Electronic Overload Relay
- Control Circuit Transformer
- Hand-Off-Auto (H-O-A) selector switch
- Red Run pilot light
- 2-NO and 1-NC auxiliaries for customer use
- Class CC Fuse holder as fused primary of CCT
- Reset pushbutton

- ① HP and NEMA size selection for line voltages shown. Contact your Sprecher + Schuh representative for other voltage application.
- ② Contactors are equipped with 2 NO and 1 NC auxiliary contact. See page C108 to order additional or different auxiliary contacts.
- ③ Dimensional information starts on page C122.

### Three Phase, Non-Reversing CATN7 @460V AC ②

NEMA Size	Max HP 1-Phase ①	Adjustment Range	Type 1 Metallic General Purpose	D I M	Type 3R Metallic Outdoor Raintight	D I M
	460V		Catalog Number		③ Catalog Number	
00	0.25	0.2...1.0	CATN7-12-XC-1EBB-G17-L11	A	CATN7-12-XA-1EBB-R17-L11	L
	0.5	1.0...5.0	CATN7-12-XC-1ECB-G17-L11	A	CATN7-12-XC-1ECB-R17-L11	L
	0.75	1.0...5.0	CATN7-12-XC-1ECB-G17-L11	A	CATN7-12-XC-1ECB-R17-L11	L
	1	1.0...5.0	CATN7-12-XC-1ECB-G17-L11	A	CATN7-12-XC-1ECB-R17-L11	L
	1.5	1.0...5.0	CATN7-12-XC-1ECB-G17-L11	A	CATN7-12-XC-1ECB-R17-L11	L
	2	1.0...5.0	CATN7-12-XC-1ECB-G17-L11	A	CATN7-12-XC-1ECB-R17-L11	L
0	3	3.2...16	CATN7-16-XC-1EDB-G17-L11	A	CATN7-16-XC-1EDB-R17-L11	L
	5	3.2...16	CATN7-16-XC-1EDB-G17-L11	A	CATN7-16-XC-1EDB-R17-L11	L
1	7.5	5.4...27	CATN7-37-XC-1EED-G17-L11	A	CATN7-37-XC-1EED-R17-L11	L
	10	5.4...27	CATN7-37-XC-1EED-G17-L11	A	CATN7-37-XC-1EED-R17-L11	L
2	15	11...55	CATN7-43-XC-1EFD-G17-L11	A	CATN7-43-XC-1EFD-R17-L11	L
	20	11...55	CATN7-43-XC-1EFD-G17-L11	A	CATN7-43-XC-1EFD-R17-L11	L
	25	11...55	CATN7-43-XC-1EFD-G17-L11	A	CATN7-43-XC-1EFD-R17-L11	L
3	30	20...100	CATN7-85-XC-1EGE-G17-L11	B	CATN7-85-XC-1EGE-R17-L11	M
	40	20...100	CATN7-85-XC-1EGE-G17-L11	B	CATN7-85-XC-1EGE-R17-L11	M
	50	20...100	CATN7-85-XC-1EGE-G17-L11	B	CATN7-85-XC-1EGE-R17-L11	M

#### Full Voltage Non-Reversing (FVNR) Features include:

- NEMA-sized CAN7 contactor
- CEP7 Electronic Overload Relay
- Control Circuit Transformer
- Hand-Off-Auto (H-O-A) selector switch
- Red Run pilot light
- 2-NO and 1-NC auxiliaries for customer use
- Class CC Fuse holder as fused primary of CCT
- Reset pushbutton

### Three Phase, Non-Reversing CATN7 @575V AC ②

NEMA Size	Max HP 3-Phase ①	Adjustment Range	Type 1 Metallic General Purpose	D I M	Type 3R Metallic Outdoor Raintight	D I M
	575V		Catalog Number		③ Catalog Number	
00	0.25	0.2...1.0	CATN7-12-XD-1EBB-G17-L11	A	CATN7-12-XD-1EBB-R17-L11	L
	0.5	1.0...5.0	CATN7-12-XD-1ECB-G17-L11	A	CATN7-12-XD-1ECB-R17-L11	L
	0.75	1.0...5.0	CATN7-12-XD-1ECB-G17-L11	A	CATN7-12-XD-1ECB-R17-L11	L
	1	1.0...5.0	CATN7-12-XD-1ECB-G17-L11	A	CATN7-12-XD-1ECB-R17-L11	L
	2	1.0...5.0	CATN7-12-XD-1ECB-G17-L11	A	CATN7-12-XD-1ECB-R17-L11	L
	3	3.2...16	CATN7-16-XD-1EDB-G17-L11	A	CATN7-16-XD-1EDB-R17-L11	L
0	5	3.2...16	CATN7-16-XD-1EDB-G17-L11	A	CATN7-16-XD-1EDB-R17-L11	L
	7.5	5.4...27	CATN7-37-XD-1EED-G17-L11	A	CATN7-37-XD-1EED-R17-L11	L
1	10	5.4...27	CATN7-37-XD-1EED-G17-L11	A	CATN7-37-XD-1EED-R17-L11	L
	15	11...55	CATN7-43-XD-1EFD-G17-L11	A	CATN7-43-XD-1EFD-R17-L11	L
2	20	11...55	CATN7-43-XD-1EFD-G17-L11	A	CATN7-43-XD-1EFD-R17-L11	L
	25	11...55	CATN7-43-XD-1EFD-G17-L11	A	CATN7-43-XD-1EFD-R17-L11	L
	30	20...100	CATN7-85-XD-1EGE-G17-L11	B	CATN7-85-XD-1EGE-R17-L11	M
3	40	20...100	CATN7-85-XD-1EGE-G17-L11	B	CATN7-85-XD-1EGE-R17-L11	M
	50	20...100	CATN7-85-XD-1EGE-G17-L11	B	CATN7-85-XD-1EGE-R17-L11	M

#### Full Voltage Non-Reversing (FVNR) Features include:

- NEMA-sized CAN7 contactor
- CEP7 Electronic Overload Relay
- Control Circuit Transformer
- Hand-Off-Auto (H-O-A) selector switch
- Red Run pilot light
- 2-NO and 1-NC auxiliaries for customer use
- Class CC Fuse holder as fused primary of CCT
- Reset pushbutton

- ① HP and NEMA size selection for line voltages shown. Contact your Sprecher + Schuh representative for other voltage application.
- ② Contactors are equipped with 2 NO and 1 NC auxiliary contact. See page C108 to order additional or different auxiliary contacts.
- ③ Dimensional information starts on page C122.

### Single Phase, Non-Reversing CBTN7

NEMA Size	Maximum HP Single $\phi$		Aux. Contacts per Contactor ①		Open Type	Type 1 General Purpose	D I M	Type 12 [Type 3R ②] Industrial Dusttight	D I M
	115V	230V	NO	NC					
00	.33	1	1	0	CBTN7-12-* $\blacklozenge$	CBTN7-12-* $\blacklozenge$ -G0	A	CBTN7-12-* $\blacklozenge$ -D0	L
0	1	2	1	0	CBTN7-16-* $\blacklozenge$	CBTN7-16-* $\blacklozenge$ -G0	A	CBTN7-16-* $\blacklozenge$ -D0	L
1	2	3	1	0	CBTN7-37-* $\blacklozenge$	CBTN7-37-* $\blacklozenge$ -G0	A	CBTN7-37-* $\blacklozenge$ -D0	L
2	3	7.5	1	0	CBTN7-43-* $\blacklozenge$	CBTN7-43-* $\blacklozenge$ -G0	A	CBTN7-43-* $\blacklozenge$ -D0	L
3	7.5	15	1	0	CBTN7-85-* $\blacklozenge$	CBTN7-85-* $\blacklozenge$ -G0	B	CBTN7-85-* $\blacklozenge$ -D0	M

### Single Phase, Non-Reversing CBTN7

NEMA Size	Maximum HP Single $\phi$		Aux. Contacts per Contactor ①		Type 4 Watertight	D I M	Type 4X Watertight Corrosion Resistant Non-metallic	D I M
	115V	230V	NO	NC				
00	.33	1	1	0	CBTN7-12-* $\blacklozenge$ -W0	N	CBTN7-12-* $\blacklozenge$ -C0	S1
0	1	2	1	0	CBTN7-16-* $\blacklozenge$ -W0	N	CBTN7-16-* $\blacklozenge$ -C0	S1
1	2	3	1	0	CBTN7-37-* $\blacklozenge$ -W0	N	CBTN7-37-* $\blacklozenge$ -C0	U1
2	3	7.5	1	0	CBTN7-43-* $\blacklozenge$ -W0	N	CBTN7-43-* $\blacklozenge$ -C0	U1
3	7.5	15	1	0	CBTN7-85-* $\blacklozenge$ -W0	O	CBTN7-85-* $\blacklozenge$ -C0	U1

**NOTE:** Catalog numbers and enclosure dimensions reflect contactors with AC coils. For DC coils, select Coil Code from the DC Coil Code table on page C104 and follow the instructions for modifying catalog numbers.

### Ordering Instructions

Specify Catalog Number	
Replace (*) with Coil Code	See page C104 See pages C105-C106 See pages C107-C111
Replace $\blacklozenge$ with O/L Relay	
Factory Modifications available	

- ① Contactors are equipped with number and type of auxiliaries indicated. See page C108 to order additional or different auxiliary contacts.
- ② For Type 3R outdoor applications, replace "D" in catalog number with an "R". Dimensions may change. For example number CBTN7-37-\* $\blacklozenge$ -D0 becomes CBTN7-37-\* $\blacklozenge$ -R0. Price remains the same.
- ③ Dimensional information starts on page C122.



### Non-Reversing , Non-Reversing CBTN7 @115V AC ②

NEMA Size	Max HP 1-Phase ①	Adjustment Range	Type 1 Metallic General Purpose	D I M	Type 3R Metallic Outdoor Raintight	D I M
	115V		Catalog Number		③ Catalog Number	
00	0.33	3.2...16	CBTN7-12-120-1EDB-G17-L11	A	CBTN7-12-120-1EDB-R17-L11	L
0	0.5	5.4...27	CBTN7-16-120-1EEB-G17-L11	A	CBTN7-16-120-1EEB-R17-L11	L
	0.75	5.4...27	CBTN7-16-120-1EEB-G17-L11	A	CBTN7-16-120-1EEB-R17-L11	L
	1	5.4...27	CBTN7-16-120-1EEB-G17-L11	A	CBTN7-16-120-1EEB-R17-L11	L
1	1.5	11...55	CBTN7-37-120-1EFD-G17-L11	A	CBTN7-37-120-1EFD-R17-L11	L
	2	11...55	CBTN7-37-120-1EFD-G17-L11	A	CBTN7-37-120-1EFD-R17-L11	L
2	3	11...55	CBTN7-43-120-1EFD-G17-L11	A	CBTN7-43-120-1EFD-R17-L11	L
3	5	20...100	CBTN7-85-120-1EGE-G17-L11	B	CBTN7-85-120-1EGE-R17-L11	M
	7.5	20...100	CBTN7-85-120-1EGE-G17-L11	B	CBTN7-85-120-1EGE-R17-L11	M

#### Full Voltage Non-Reversing (FVNR) Features include:

- NEMA-sized CAN7 contactor
- CEP7 Electronic Overload Relay
- Control Circuit Transformer
- Hand-Off-Auto (H-O-A) selector switch
- Red Run pilot light
- 2-NO and 1-NC auxiliaries for customer use
- Class CC Fuse holder as fused primary of CCT
- Reset pushbutton

**C**  
NEMA Starters

### Single Phase, Non-Reversing CBTN7 @230V AC ②

NEMA Size	Max HP 1-Phase ①	Adjustment Range	Type 1 Metallic General Purpose	D I M	Type 3R Metallic Outdoor Raintight	D I M
	230V		Catalog Number		③ Catalog Number	
00	0.25	1.0...5.0	CBTN7-12-220W-1ECB-G17-L11	A	CBTN7-12-220W-1ECB-R17-L11	L
	0.5	1.0...5.0	CBTN7-12-220W-1ECB-G17-L11	A	CBTN7-12-220W-1EDB-R17-L11	L
	0.75	3.2...16	CBTN7-12-220W-1EDB-G17-L11	A	CBTN7-12-220W-1EDB-R17-L11	L
	1	3.2...16	CBTN7-12-220W-1EDB-G17-L11	A	CBTN7-12-220W-1EDB-R17-L11	L
0	1.5	5.4...27	CBTN7-16-220W-1EEB-G17-L11	A	CBTN7-16-220W-1EEB-R17-L11	L
	2	5.4...27	CBTN7-16-220W-1EEB-G17-L11	A	CBTN7-16-220W-1EEB-R17-L11	L
1	3	11...55	CBTN7-37-220W-1EFD-G17-L11	A	CBTN7-37-220W-1EFD-R17-L11	L
2	5	11...55	CBTN7-43-220W-1EFD-G17-L11	A	CBTN7-43-220W-1EFD-R17-L11	L
	7.5	11...55	CBTN7-43-220W-1EFD-G17-L11	A	CBTN7-43-220W-1EFD-R17-L11	L
3	10	20...100	CBTN7-85-220W-1EGE-G17-L11	B	CBTN7-85-220W-1EGE-R17-L11	M
	15	20...100	CBTN7-85-220W-1EGE-G17-L11	B	CBTN7-85-220W-1EGE-R17-L11	M

- ① HP and NEMA size selection for line voltages shown. Contact your Sprecher + Schuh representative for other voltage application.
- ② Contactors are equipped with 2 NO and 1 NC Auxiliary contacts. See page C108 to order additional or different auxiliary contacts.
- ③ Dimensional information starts on page C122.

# NEMA Sized Combination Starters - Through the Door Operated

**C**  
NEMA Starters

Smart and cost effective... for any application



CAN7 NEMA labeled contactor (AC)

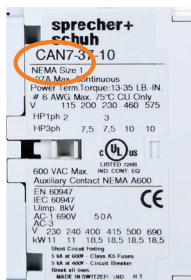

Sprecher + Schuh's through-the-door operated combination starters represent an economical alternative to the classic flange-operated combo solution. It is designed to meet rigid UL/NEC withstand specifications. Sprecher + Schuh has been building custom control panels with this design for years. Experience the durability of this product!

## Starting with the best

At the heart of all Sprecher + Schuh NEMA sized combination starters is the CATN7 line of motor starters. Each starter proudly displays the NEMA size (00, 0, 1, 2, or 3) and HP at applied voltage. This line of starters is designed to meet rigid consultant specifications for NEMA starters.

## Top line protection...

NEMA labeled combination starters are equipped with Sprecher + Schuh's premium CEP7 solid state overload relay standard. Unlike traditional overload relays that indirectly sense motor current through heater elements, CEP7 solid state overload relays measure motor current directly through integrated current transformers and on board electronics. The electronics provide numerous advantages over electromechanical relays. Alternatively, the CT7N Thermal Overload Relay may also be selected.

## Choice of Disconnect

- Choices for disconnect include:
- Thermal Magnetic Molded Case Circuit Breaker (MCCB)
- L11 Fusible or Non-Fusible Disconnect switch



## Thermal Magnetic Molded Case Circuit Breaker (MCCB)

The through-the-door operated combo MCCB is available to meet UL short circuit withstand specifications. An MCCB prevents single phasing by simultaneously opening all three phases when a fault occurs in any one phase. An MCCB can often be reset after the fault has been cleared.

## Disconnect Switches

The through-the-door operated combo is available with the L11 switch. A mechanical door interlock system prevents the door from being opened when the disconnect is closed, and conversely, prevents the disconnect from being closed when the door is open. Both functions can be defeated for test and maintenance purposes. Other safety features include padlock provisions and a high visibility operating handle.

The L11 Switch disconnects have a quick make/quick break, non-teasing action. The L11 fusible switch is suitable for interrupting up to 100,000 amperes when class "J" fuses are used. All L11 disconnect switches conform to UL 98 standards.

## Choice of Enclosures

- Available enclosures include;
- Type 1 General Purpose
- Type 3R Raintight
- Type 12 Dusttight
- Type 4 Watertight
- Type 4X Corrosion Resistant

### Series CATN7 with Thermal-Magnetic Circuit Breaker

NEMA Size	Maximum Horsepower Three Phase				MCCB Amps	Type 1 General Purpose	D I M	Type 12 [Type 3R Ⓣ]	D I M	Type 4 Watertight	D I M	Type 4X Watertight Corrosion Resistant Non-metallic	D I M
	200V	230V	460V	575V		Catalog No.		Ⓣ Catalog No.		Ⓣ Catalog No.		Ⓣ Catalog No.	
						CATN		CATN		CATN		CATN	
00	1.5	1.5	2	2 Ⓣ	15	7-12-*◆-TB15G0	C2	7-12-*◆-TB15D0	C3	7-12-*◆-TB15W0	C2	7-12-*◆-TB15C0	V2
	2	2	5	5 Ⓣ	15	7-16-*◆-TB15G0	C2	7-16-*◆-TB15D0	C3	7-16-*◆-TB15W0	C2	7-16-*◆-TB15C0	V2
	3	3	~	~	20	7-16-*◆-TB20G0	C2	7-16-*◆-TB20D0	C3	7-16-*◆-TB20W0	C2	7-16-*◆-TB20C0	V2
1	~	~	7.5	10 Ⓣ	20	7-37-*◆-TB20G0	C2	7-37-*◆-TB20D0	C3	7-37-*◆-TB20W0	C2	7-37-*◆-TB20C0	V2
	~	5	10	~	30	7-37-*◆-TB30G0	C2	7-37-*◆-TB30D0	C3	7-37-*◆-TB30W0	C2	7-37-*◆-TB30C0	V2
	5	~	~	~	35	7-37-*◆-TB35G0	C2	7-37-*◆-TB35D0	C3	7-37-*◆-TB35W0	C2	7-37-*◆-TB35C0	V2
	~	7.5	~	~	40	7-37-*◆-TB40G0	C2	7-37-*◆-TB40D0	C3	7-37-*◆-TB40W0	C2	7-37-*◆-TB40C0	V2
	7.5	~	~	~	50	7-37-*◆-TB50G0	C2	7-37-*◆-TB50D0	C3	7-37-*◆-TB50W0	C2	7-37-*◆-TB50C0	V2
	~	~	~	15 Ⓣ	35	7-43-*◆-TB35G0	C2	7-43-*◆-TB35D0	C3	7-43-*◆-TB35W0	C2	7-43-*◆-TB35C0	V2
2	~	~	15	20 Ⓣ	40	7-43-*◆-TB40G0	C2	7-43-*◆-TB40D0	C3	7-43-*◆-TB40W0	C2	7-43-*◆-TB40C0	V2
	~	10	20	25 Ⓣ	50	7-43-*◆-TB50G0	C2	7-43-*◆-TB50D0	C3	7-43-*◆-TB50W0	C2	7-43-*◆-TB50C0	V2
	10	~	25	~	60	7-43-*◆-TB60G0	C2	7-43-*◆-TB60D0	C3	7-43-*◆-TB60W0	C2	7-43-*◆-TB60C0	V2
	~	15	~	~	80	7-43-*◆-TB80G0	C2	7-43-*◆-TB80D0	C3	7-43-*◆-TB80W0	C2	7-43-*◆-TB80C0	V2
	~	~	~	30 Ⓣ	60	7-85-*◆-TB60G0	D3	7-85-*◆-TB60D0	Q	7-85-*◆-TB60W0	Q	7-85-*◆-TB60C0	W2
3	~	~	30	40 Ⓣ	80	7-85-*◆-TB80G0	D3	7-85-*◆-TB80D0	Q	7-85-*◆-TB80W0	Q	7-85-*◆-TB80C0	W2
	15	20	40	50 Ⓣ	100	7-85-*◆-TB100G0	D3	7-85-*◆-TB100D0	Q	7-85-*◆-TB100W0	Q	7-85-*◆-TB100C0	W2
	25	30	50	~	125	7-85-*◆-TB125G0	D3	7-85-*◆-TB125D0	Q	7-85-*◆-TB125W0	Q	7-85-*◆-TB125C0	W2

**NOTE:** Catalog numbers and enclosure dimensions reflect contactors with AC coils. For DC coils, select Coil Code from the DC Coil Code table on page C104 and follow the instructions for modifying catalog numbers.

### Ordering Instructions

Specify Catalog Number	
Replace (*) with Coil Code	See page C104 See pages C105-C106 See pages C107-C111
Replace ◆ with O/L Relay	
Factory Modifications available	

- Ⓣ Dimensional information starts on page C122.
- Ⓣ For Type 3R outdoor applications, replace "D" in catalog number with an "R". Dimensions may change. For example number CATN7-37-\*◆-TB40D0 becomes CATN7-37-\*◆-TB40R0. Price remains the same.
- Ⓣ Applicable to 600Y/347V only. Refer to next page for 600V Delta solution.

### Series CATN7 with Thermal-Magnetic Circuit Breaker - 600V Delta

NEMA Size	Maximum Horsepower Three Phase				MCCB Amps	Type 1 General Purpose	D I M	Type 12 [Type 3R ☉] Industrial Dusttight	D I M	Type 4 Watertight	D I M	Type 4X Watertight Corrosion Resistant Non-metallic	D I M
	200V	230V	460V	575V		Catalog No.	①	Catalog No.	①	Catalog No.	①	Catalog No.	①
						CATN		CATN		CATN		CATN	
00	1.5	1.5	2	2	15	7-12-*◆-TBH15G0	C2	7-12-*◆-TBH15D0	C3	7-12-*◆-TBH15W0	C2	7-12-*◆-TBH15C0	V2
0	2	3	5	5	15	7-16-*◆-TBH15G0	C2	7-16-*◆-TBH15D0	C3	7-16-*◆-TBH15W0	C2	7-16-*◆-TBH15C0	V2
1	~	~	7.5	10	20	7-37-*◆-TBH20G0	C2	7-37-*◆-TBH20D0	C3	7-37-*◆-TBH20W0	C2	7-37-*◆-TBH20C0	V2
2	~	~	~	15	35	7-43-*◆-TBH35G0	C2	7-43-*◆-TBH35D0	C3	7-43-*◆-TBH35W0	C2	7-43-*◆-TBH35C0	V2
	~	~	15	20	40	7-43-*◆-TBH40G0	C2	7-43-*◆-TBH40D0	C3	7-43-*◆-TBH40W0	C2	7-43-*◆-TBH40C0	V2
	~	~	20	25	50	7-43-*◆-TBH50G0	C2	7-43-*◆-TBH50D0	C3	7-43-*◆-TBH50W0	C2	7-43-*◆-TBH50C0	V2
3	~	~	~	30	60	7-85-*◆-TBH60G0	D3	7-85-*◆-TBH60D0	Q	7-85-*◆-TBH60W0	Q	7-85-*◆-TBH60C0	W2
	~	~	30	40	80	7-85-*◆-TBH80G0	D3	7-85-*◆-TBH80D0	Q	7-85-*◆-TBH80W0	Q	7-85-*◆-TBH80C0	W2
	15	20	40	50	100	7-85-*◆-TBH100G0	D3	7-85-*◆-TBH100D0	Q	7-85-*◆-TBH100W0	Q	7-85-*◆-TBH100C0	W2

**NOTE:** Catalog numbers and enclosure dimensions reflect contactors with AC coils. For DC coils, select Coil Code from the DC Coil Code table on page C104 and follow the instructions for modifying catalog numbers.

### Ordering Instructions

Specify Catalog Number	
Replace (*) with Coil Code	See page C104 See pages C105-C106 See pages C107-C111
Replace (◆) with O/L Relay	
Factory Modifications available	

- ① Dimensional information starts on page C122.
- ② For Type 3R outdoor applications, replace "D" in catalog number with an "R". Dimensions may change. For example number CATN7-37-\*◆-TBH40D0 becomes CATN7-37-\*◆-TBH40R0. Price remains the same.

### Series CATN7 208V AC with Thermal-Magnetic Circuit Breaker ②

NEMA Size	Max HP 3-Phase ①	Adjustment Range	MCCB Amps	Type 1 Metallic General Purpose	D I M	Type 3R Metallic Outdoor Raintight	D I M
				Catalog No.		③ Catalog No.	
00	0.25	0.2...1.0	15	CATN7-12-XA-1EBB-TB15G17-L11	C2	CATN7-12-XA-1EBB-TB15R17-L11	0
	0.5	1.0...5.0	15	CATN7-12-XA-1ECB-TB15G17-L11	C2	CATN7-12-XA-1ECB-TB15R17-L11	0
	0.75	1.0...5.0	15	CATN7-12-XA-1ECB-TB15G17-L11	C2	CATN7-12-XA-1ECB-TB15R17-L11	0
	1	1.0...5.0	15	CATN7-12-XA-1ECB-TB15G17-L11	C2	CATN7-12-XA-1ECB-TB15R17-L11	0
	1.5	3.2...16	15	CATN7-12-XA-1EDB-TB15G17-L11	C2	CATN7-12-XA-1EDB-TB15R17-L11	0
0	2	3.2...16	15	CATN7-16-XA-1EDB-TB15G17-L11	C2	CATN7-16-XA-1EDB-TB15R17-L11	0
	3	3.2...16	20	CATN7-16-XA-1EDB-TB20G17-L11	C2	CATN7-16-XA-1EDB-TB20R17-L11	0
1	5	5.4...27	35	CATN7-37-XA-1EED-TB35G17-L11	C2	CATN7-37-XA-1EED-TB35R17-L11	0
	7.5	5.4...27	50	CATN7-37-XA-1EED-TB50G17-L11	C2	CATN7-37-XA-1EED-TB50R17-L11	0
2	10	11...55	60	CATN7-43-XA-1EFD-TB60G17-L11	C2	CATN7-43-XA-1EFD-TB60R17-L11	0
3	15	20...100	100	CATN7-85-XA-1EGE-TB100G17-L11	D3	CATN7-85-XA-1EGE-TB100R17-L11	0
	20	20...100	125	CATN7-85-XA-1EGE-TB125G17-L11	D3	CATN7-85-XA-1EGE-TB125R17-L11	0
	25	20...100	125	CATN7-85-XA-1EGE-TB125G17-L11	D3	CATN7-85-XA-1EGE-TB125R17-L11	0

#### Full Voltage Non-Reversing (FVNR) Features include:

- NEMA-sized CAN7 contactor
- CEP7 Electronic Overload Relay
- Control Circuit Transformer
- Hand-Off-Auto (H-O-A) selector switch
- Red Run pilot light
- 2-NO and 1-NC auxiliaries for customer use
- Class CC Fuse holder as fused primary of CCT
- Reset pushbutton
- UL489 600V class thermal-magnetic molded case circuit breaker



**C**  
NEMA Starters

### Series CATN7 230V AC with Thermal-Magnetic Circuit Breaker ②

NEMA Size	Max HP 3-Phase ①	Adjustment Range	MCCB Amps	Type 1 Metallic General Purpose	D I M	Type 3R Metallic Outdoor Raintight	D I M
				Catalog No.		③ Catalog No.	
00	0.25	0.2...1.0	15	CATN7-12-XB-1EBB-TB15G17-L11	C2	CATN7-12-XB-1EBB-TB15R17-L11	0
	0.5	1.0...5.0	15	CATN7-12-XB-1ECB-TB15G17-L11	C2	CATN7-12-XB-1ECB-TB15R17-L11	0
	0.75	1.0...5.0	15	CATN7-12-XB-1ECB-TB15G17-L11	C2	CATN7-12-XB-1ECB-TB15R17-L11	0
	1	1.0...5.0	15	CATN7-12-XB-1ECB-TB15G17-L11	C2	CATN7-12-XB-1ECB-TB15R17-L11	0
	1.5	1.0...5.0	15	CATN7-12-XB-1ECB-TB15G17-L11	C2	CATN7-12-XB-1ECB-TB15R17-L11	0
0	2	3.2...16	15	CATN7-16-XB-1EDB-TB15G17-L11	C2	CATN7-16-XB-1EDB-TB15R17-L11	0
	3	3.2...16	15	CATN7-16-XB-1EDB-TB15G17-L11	C2	CATN7-16-XB-1EDB-TB15R17-L11	0
1	5	5.4...27	30	CATN7-37-XB-1EED-TB30G17-L11	C2	CATN7-37-XB-1EED-TB30R17-L11	0
	7.5	5.4...27	40	CATN7-37-XB-1EED-TB40G17-L11	C2	CATN7-37-XB-1EED-TB40R17-L11	0
2	10	11...55	60	CATN7-43-XB-1EFD-TB60G17-L11	C2	CATN7-43-XB-1EFD-TB60R17-L11	0
	15	11...55	80	CATN7-43-XB-1EFD-TB80G17-L11	C2	CATN7-43-XB-1EFD-TB80R17-L11	0
3	20	20...100	100	CATN7-85-XB-1EGE-TB100G17-L11	D3	CATN7-85-XB-1EGE-TB100R17-L11	0
	25	20...100	125	CATN7-85-XB-1EGE-TB125G17-L11	D3	CATN7-85-XB-1EGE-TB125R17-L11	0
	30	20...100	150	CATN7-85-XB-1EGE-TB150G17-L11	D3	CATN7-85-XB-1EGE-TB150R17-L11	0

- ① HP and NEMA size selection for line voltages shown. Contact your Sprecher + Schuh representative for other voltage application.
- ② Contactors are equipped with 2 NO and 1 NC auxiliary contacts. See page C108 to order additional or different auxiliary contacts.
- ③ Dimensional information starts on page C122.



### Series CATN7 460V AC with Thermal-Magnetic Circuit Breaker

NEMA Size	Max HP 3-Phase 	Adjustment Range	MCCB Amps	Type 1 Metallic General Purpose	D I M	Type 3R Metallic Outdoor Raintight	D I M	
				Catalog No.				Catalog No.
00	460V	0.25	0.2...1.0	15	CATN7-12-XC-1EBB-TB15G17-L11	C2	CATN7-12-XC-1EBB-TB15R17-L11	0
	0.5	1.0...5.0	15	CATN7-12-XC-1ECB-TB15G17-L11	C2	CATN7-12-XC-1ECB-TB15R17-L11	0	
	0.75	1.0...5.0	15	CATN7-12-XC-1ECB-TB15G17-L11	C2	CATN7-12-XC-1ECB-TB15R17-L11	0	
	1	1.0...5.0	15	CATN7-12-XC-1ECB-TB15G17-L11	C2	CATN7-12-XC-1ECB-TB15R17-L11	0	
	1.5	1.0...5.0	15	CATN7-12-XC-1ECB-TB15G17-L11	C2	CATN7-12-XC-1ECB-TB15R17-L11	0	
	2	1.0...5.0	15	CATN7-12-XC-1ECB-TB15G17-L11	C2	CATN7-12-XC-1ECB-TB15R17-L11	0	
0	3	3.2...16	15	CATN7-16-XC-1EDB-TB15G17-L11	C2	CATN7-16-XC-1EDB-TB15R17-L11	0	
	5	3.2...16	15	CATN7-16-XC-1EDB-TB15G17-L11	C2	CATN7-16-XC-1EDB-TB15R17-L11	0	
1	7.5	5.4...27	20	CATN7-37-XC-1EED-TB20G17-L11	C2	CATN7-37-XC-1EED-TB20R17-L11	0	
	10	5.4...27	30	CATN7-37-XC-1EED-TB30G17-L11	C2	CATN7-37-XC-1EED-TB30R17-L11	0	
2	15	11...55	40	CATN7-43-XC-1EFD-TB40G17-L11	C2	CATN7-43-XC-1EFD-TB40R17-L11	0	
	20	11...55	50	CATN7-43-XC-1EFD-TB50G17-L11	C2	CATN7-43-XC-1EFD-TB50R17-L11	0	
	25	11...55	60	CATN7-43-XC-1EFD-TB60G17-L11	C2	CATN7-43-XC-1EFD-TB60R17-L11	0	
3	30	20...100	80	CATN7-85-XC-1EGE-TB80G17-L11	D3	CATN7-85-XC-1EGE-TB80R17-L11	0	
	40	20...100	100	CATN7-85-XC-1EGE-TB100G17-L11	D3	CATN7-85-XC-1EGE-TB100R17-L11	0	
	50	20...100	125	CATN7-85-XC-1EGE-TB125G17-L11	D3	CATN7-85-XC-1EGE-TB125R17-L11	0	

#### Full Voltage Non-Reversing (FVNR) Features include:

- NEMA-sized CAN7 contactor
- CEP7 Electronic Overload Relay
- Control Circuit Transformer
- Hand-Off-Auto (H-O-A) selector switch
- Red Run pilot light
- 2-NO and 1-NC auxiliaries for customer use
- Class CC Fuse holder as fused primary of CCT
- Reset pushbutton
- UL489 600V class thermal-magnetic molded case circuit breaker

NEMA Starters

-  HP and NEMA size selection for line voltages shown. Contact your Sprecher + Schuh representative for other voltage application.
-  Contactors are equipped with 2 NO and 1 NC auxiliary contacts standard. See page C108 to order additional or different auxiliary contacts.
-  Dimensional information starts on page C122.

### Series CATN7 575V AC with Thermal-Magnetic Circuit Breaker ②

NEMA Size	Max HP 3-Phase ①	Adjustment Range	MCCB Amps	Type 1 Metallic General Purpose (except TBH)	D I M	Type 3R Metallic Outdoor Raintight	D I M
	575V			Catalog No.		③ Catalog No.	
00	0.25	0.2...1.0	15	CATN7-12-XD-1EBB-TBH15G17-L11	C2	CATN7-12-XD-1EBB-TBH15R17-L11	0
	0.5	1.0...5.0	15	CATN7-12-XD-1ECB-TBH15G17-L11	C2	CATN7-12-XD-1ECB-TBH15R17-L11	0
	0.75	1.0...5.0	15	CATN7-12-XD-1ECB-TBH15G17-L11	C2	CATN7-12-XD-1ECB-TBH15R17-L11	0
	1	1.0...5.0	15	CATN7-12-XD-1ECB-TBH15G17-L11	C2	CATN7-12-XD-1ECB-TBH15R17-L11	0
	2	1.0...5.0	15	CATN7-12-XD-1ECB-TBH15G17-L11	C2	CATN7-12-XD-1ECB-TBH15R17-L11	0
0	3	3.2...16	15	CATN7-16-XD-1EDB-TBH15G17-L11	C2	CATN7-16-XD-1EDB-TBH15R17-L11	0
	5	3.2...16	15	CATN7-16-XD-1EDB-TBH15G17-L11	C2	CATN7-16-XD-1EDB-TBH15R17-L11	0
1	7.5 ④	5.4...27	20	CATN7-37-XD-1EED-TB20G17-L11	C2	CATN7-37-XD-1EED-TB20R17-L11	0
	10 ④	9...45	20	CATN7-37-XD-1EFD-TB20G17-L11	C2	CATN7-37-XD-1EED-TB20R17-L11	0
	7.5	5.4...27	20	CATN7-37-XD-1EED-TBH20G17-L11	C2	CATN7-37-XD-1EED-TBH20R17-L11	0
	10	11...55	20	CATN7-37-XD-1EFD-TBH20G17-L11	C2	CATN7-37-XD-1EFD-TBH20R17-L11	0
2	15 ④	11...55	35	CATN7-43-XD-1EFD-TB35G17-L11	C2	CATN7-43-XD-1EFD-TB35R17-L11	0
	20 ④	11...55	40	CATN7-43-XD-1EFD-TB40G17-L11	C2	CATN7-43-XD-1EFD-TB40R17-L11	0
	25 ④	11...55	50	CATN7-43-XD-1EFD-TB50G17-L11	C2	CATN7-43-XD-1EFD-TB50R17-L11	0
	15	11...55	35	CATN7-43-XD-1EFD-TBH35G17-L11	C2	CATN7-43-XD-1EFD-TBH35R17-L11	0
	20	11...55	40	CATN7-43-XD-1EFD-TBH40G17-L11	C2	CATN7-43-XD-1EFD-TBH40R17-L11	0
3	25	11...55	50	CATN7-43-XD-1EFD-TBH50G17-L11	C2	CATN7-43-XD-1EFD-TBH50R17-L11	0
	30 ④	20...100	60	CATN7-85-XD-1EGE-TB60G17-L11	D3	CATN7-85-XD-1EGE-TB60R17-L11	0
	40 ④	20...100	80	CATN7-85-XD-1EGE-TB80G17-L11	D3	CATN7-85-XD-1EGE-TB80R17-L11	0
	50 ④	20...100	100	CATN7-85-XD-1EGE-TB100G17-L11	D3	CATN7-85-XD-1EGE-TB100R17-L11	0
	30	20...100	60	CATN7-85-XD-1EGE-TBH60G17-L11	D3	CATN7-85-XD-1EGE-TBH60R17-L11	0
	40	20...100	80	CATN7-85-XD-1EGE-TBH80G17-L11	D3	CATN7-85-XD-1EGE-TBH80R17-L11	0
	50	20...100	100	CATN7-85-XD-1EGE-TBH100G17-L11	D3	CATN7-85-XD-1EGE-TBH100R17-L11	0

#### Full Voltage Non-Reversing (FVNR) Features include:

- NEMA-sized CAN7 contactor
- CEP7 Electronic Overload Relay
- Control Circuit Transformer
- Hand-Off-Auto (H-O-A) selector switch
- Red Run pilot light
- 2-NO and 1-NC auxiliaries for customer use
- Class CC Fuse holder as fused primary of CCT
- Reset pushbutton
- UL489 600V class thermal-magnetic molded case circuit breaker

**C**  
NEMA Starters

- ① HP and NEMA size selection for line voltages shown. Contact your Sprecher + Schuh representative for other voltage application.
- ② Contactors are equipped with 2 NO and 1 NC auxiliary contacts standard. See page C108 to order additional or different auxiliary contacts.
- ③ Dimensional information starts on page C122.
- ④ Applicable to 600Y/347V only.

#### Series CATN7 with Fusible Disconnect (J-Type) ③④

NEMA Size	Maximum Horsepower Three Phase				Fuse Clip Amps	Type 1 General Purpose	D I M	Type 12 [Type 3R ☉] Industrial Dusttight	D I M	Type 4 Watertight	D I M	Type 4X Watertight Corrosion Resistant Non-metallic	D I M
	200V	230V	460V	575V		Catalog No.		① Catalog No.		① Catalog No.		① Catalog No.	
						CATN		CATN		CATN		CATN	
00	1.5	1.5	2	2	30	7-12-*◆-JF61G0	C	7-12-*◆-JF61D0	C2	7-12-*◆-JF61W0	Q	7-12-*◆-JF61C0	V1
0	3	3	5	5	30	7-16-*◆-JF61G0	C	7-16-*◆-JF61D0	C2	7-16-*◆-JF61W0	Q	7-16-*◆-JF61C0	V1
1	5	5	10	10	30	7-37-*◆-JF61G0	C	7-37-*◆-JF61D0	C2	7-37-*◆-JF61W0	Q	7-37-*◆-JF61C0	V1
	7-1/2	7.5	~	~	60	7-37-*◆-JF62G0	C	7-37-*◆-JF62D0	C2	7-37-*◆-JF62W0	Q	7-37-*◆-JF62C0	V1
2	~	~	~	15	30	7-43-*◆-JF61G0	C	7-43-*◆-JF61D0	C2	7-43-*◆-JF61W0	Q	7-43-*◆-JF61C0	V1
	10	10	25	25	60	7-43-*◆-JF62G0	C	7-43-*◆-JF62D0	C2	7-43-*◆-JF62W0	Q	7-43-*◆-JF62C0	V1
	~	15	~	~	100	7-43-*◆-JF63G0	D3	7-43-*◆-JF63D0	Q	7-43-*◆-JF63W0	Q	7-43-*◆-JF63C0	W1
3	~	~	30	40	60	7-85-*◆-JF62G0	D3	7-85-*◆-JF62D0	Q	7-85-*◆-JF62W0	Q	7-85-*◆-JF62C0	W2
	20	25	50	50	100	7-85-*◆-JF63G0	D3	7-85-*◆-JF63D0	Q	7-85-*◆-JF63W0	Q	7-85-*◆-JF63C0	W2
	25	30	~	~	200	7-85-*◆-JF64G0	G	7-85-*◆-JF64D0	T	7-85-*◆-JF64W0	T	7-85-*◆-JF64C0	X1

**NOTE:** Catalog numbers and enclosure dimensions reflect contactors with AC coils. For DC coils, select Coil Code from the DC Coil Code table on page C104 and follow the instructions for modifying catalog numbers.

#### Ordering Instructions

Specify Catalog Number	
Replace (*) with Coil Code	See page C104 See pages C105-C106 See pages C107-C111
Replace (◆) with O/L Relay	
Factory Modifications available	

- ① Dimensional information starts on page C122.
- ② For Type 3R outdoor applications, replace "D" in catalog number with an "R". Dimensions may change. For example number CATN7-16-\*◆-JF61D0 becomes CATN7-16-\*◆-JF61R0. Price remains the same.
- ③ Fusible combo starter uses the L11 Disconnect. Fuse clips accept "J" type fuses. Power fuses not supplied.
- ④ A Red and Yellow Handle may be selected instead of the standard Black handle. Change "JF" to "LF" in catalog number.



### Series CATN7 208V AC with Fusible Disconnect (J-Type) ②③④

NEMA Size	Max HP 3-Phase ①	Adjustment Range	Fuse Clip Amps	Type 1 Metallic General Purpose	D I M	Type 3R Metallic Outdoor Raintight	D I M
	208V			Catalog No.		⑤ Catalog No.	
00	0.25	0.2...1.0	30	CATN7-12-XA-1EBB-JF61G17-L11	C	CATN7-12-XA-1EBB-JF61R17-L11	0
	0.5	1.0...5.0	30	CATN7-12-XA-1ECB-JF61G17-L11	C	CATN7-12-XA-1ECB-JF61R17-L11	0
	0.75	1.0...5.0	30	CATN7-12-XA-1ECB-JF61G17-L11	C	CATN7-12-XA-1ECB-JF61R17-L11	0
	1	1.0...5.0	30	CATN7-12-XA-1ECB-JF61G17-L11	C	CATN7-12-XA-1ECB-JF61R17-L11	0
	1.5	3.2...16	30	CATN7-12-XA-1EDB-JF61G17-L11	C	CATN7-12-XA-1EDB-JF61R17-L11	0
0	2	3.2...16	30	CATN7-16-XA-1EDB-JF61G17-L11	C	CATN7-16-XA-1EDB-JF61R17-L11	0
	3	3.2...16	30	CATN7-16-XA-1EDB-JF61G17-L11	C	CATN7-16-XA-1EDB-JF61R17-L11	0
1	5	5.4...27	30	CATN7-37-XA-1EED-JF61G17-L11	C	CATN7-37-XA-1EED-JF61R17-L11	0
	7.5	5.4...27	60	CATN7-37-XA-1EED-JF62G17-L11	C	CATN7-37-XA-1EED-JF62R17-L11	0
2	10	11...55	60	CATN7-43-XA-1EFD-JF62G17-L11	C	CATN7-43-XA-1EFD-JF62R17-L11	0
3	15	20...100	100	CATN7-85-XA-1EGE-JF63G17-L11	D3	CATN7-85-XA-1EGE-JF63R17-L11	0
	20	20...100	100	CATN7-85-XA-1EGE-JF63G17-L11	D3	CATN7-85-XA-1EGE-JF63R17-L11	0
	25	20...100	200	CATN7-85-XA-1EGE-JF64G17-L11	G	CATN7-85-XA-1EGE-JF64R17-L11	T

#### Full Voltage Non-Reversing (FVNR) Features include:

- NEMA-sized CAN7 contactor
- CEP7 Electronic Overload Relay
- Control Circuit Transformer
- Hand-Off-Auto (H-O-A) selector switch
- Red Run pilot light
- 2-NO and 1-NC auxiliaries for customer use
- Class CC Fuse holder as fused primary of CCT
- UL98 fusible L11 disconnect
- Reset pushbutton

NEMA Starters

### Series CATN7 230V AC with Fusible Disconnect (J-Type) ②③④

NEMA Size	Max HP 3-Phase ①	Adjustment Range	Fuse Clip Amps	Type 1 Metallic General Purpose	D I M	Type 3R Metallic Outdoor Raintight	D I M
	230V			Catalog No.		⑤ Catalog No.	
00	0.25	0.2...1.0	30	CATN7-12-XB-1EBB-JF61G17-L11	C	CATN7-12-XB-1EBB-JF61R17-L11	0
	0.5	1.0...5.0	30	CATN7-12-XB-1ECB-JF61G17-L11	C	CATN7-12-XB-1ECB-JF61R17-L11	0
	0.75	1.0...5.0	30	CATN7-12-XB-1ECB-JF61G17-L11	C	CATN7-12-XB-1ECB-JF61R17-L11	0
	1	1.0...5.0	30	CATN7-12-XB-1ECB-JF61G17-L11	C	CATN7-12-XB-1ECB-JF61R17-L11	0
	1.5	1.0...5.0	30	CATN7-12-XB-1ECB-JF61G17-L11	C	CATN7-12-XB-1ECB-JF61R17-L11	0
0	2	3.2...16	30	CATN7-16-XB-1EDB-JF61G17-L11	C	CATN7-16-XB-1EDB-JF61R17-L11	0
	3	3.2...16	30	CATN7-16-XB-1EDB-JF61G17-L11	C	CATN7-16-XB-1EDB-JF61R17-L11	0
1	5	5.4...27	30	CATN7-37-XB-1EED-JF61G17-L11	C	CATN7-37-XB-1EED-JF61R17-L11	0
	7.5	5.4...27	60	CATN7-37-XB-1EED-JF62G17-L11	C	CATN7-37-XB-1EED-JF62R17-L11	0
2	10	11...55	60	CATN7-43-XB-1EFD-JF62G17-L11	C	CATN7-43-XB-1EFD-JF62R17-L11	0
3	15	11...55	100	CATN7-43-XB-1EFD-JF63G17-L11	C	CATN7-43-XB-1EFD-JF63R17-L11	0
	20	20...100	100	CATN7-85-XB-1EGE-JF63G17-L11	D3	CATN7-85-XB-1EGE-JF63R17-L11	0
	25	20...100	100	CATN7-85-XB-1EGE-JF63G17-L11	D3	CATN7-85-XB-1EGE-JF63R17-L11	0
	30	20...100	200	CATN7-85-XB-1EGE-JF64G17-L11	G	CATN7-85-XB-1EGE-JF64R17-L11	T

① HP and NEMA size selection for line voltages shown. Contact your Sprecher + Schuh representative for other voltage application.

② Contactors are equipped with 2 NO and 2 NC auxiliary contacts standard. See page C108 to order additional or different auxiliary contacts.

③ Fusible combo starter uses the L11 Disconnect. Fuse clips accept "J" type fuses. Power fuses not supplied.

④ A Red and Yellow Handle may be selected instead of the standard Black handle. Change "JF" to "LF" in catalog number.

⑤ Dimensional information starts on page C122.

#### 208V Series CATN7 with Fusible Disconnect (J Type) with Power Fuses ②③④

NEMA Size	Max HP 3-Phase ①	Adjustment Range	Fuse Clip AMPS	Fuse Size	Type 1 (M1) Metallic General Purpose	D I M	Type 3R (M3) Metallic Outdoor Raintight	D I M
					Catalog Number		⑤ Catalog Number	
00	0.25	0.2...1.0	30	2	CATN7-12-XA-1EBB-JF2G17-L11	C	CATN7-12-XA-1EBB-JF2R17-L11	0
	0.5	1.0...5.0	30	3.5	CATN7-12-XA-1ECB-JF3.5G17-L11	C	CATN7-12-XA-1ECB-JF3.5R17-L11	0
	0.75	1.0...5.0	30	5	CATN7-12-XA-1ECB-JF5G17-L11	C	CATN7-12-XA-1ECB-JF5R17-L11	0
	1	1.0...5.0	30	7	CATN7-12-XA-1ECB-JF7G17-L11	C	CATN7-12-XA-1ECB-JF7R17-L11	0
	1.5	3.2...16	30	10	CATN7-12-XA-1EDB-JF10G17-L11	C	CATN7-12-XA-1EDB-JF10R17-L11	0
0	2	3.2...16	30	12	CATN7-16-XA-1EDB-JF12G17-L11	C	CATN7-16-XA-1EDB-JF12R17-L11	0
	3	3.2...16	30	15	CATN7-16-XA-1EDB-JF15G17-L11	C	CATN7-16-XA-1EDB-JF15R17-L11	0
1	5	5.4...27	30	25	CATN7-37-XA-1EED-JF25G17-L11	C	CATN7-37-XA-1EED-JF25R17-L11	0
	7.5	5.4...27	60	35	CATN7-37-XA-1EED-JF35G17-L11	C	CATN7-37-XA-1EED-JF35R17-L11	0
2	10	11...55	60	50	CATN7-43-XA-1EFD-JF50G17-L11	C	CATN7-43-XA-1EFD-JF50R17-L11	0
	15	20...100	100	70	CATN7-85-XA-1EGE-JF70G17-L11	D3	CATN7-85-XA-1EGE-JF70R17-L11	0
3	20	20...100	100	90	CATN7-85-XA-1EGE-JF90G17-L11	D3	CATN7-85-XA-1EGE-JF90R17-L11	0
	25	20...100	100	110	CATN7-85-XA-1EGE-JF110G17-L11	G	CATN7-85-XA-1EGE-JF110R17-L11	T

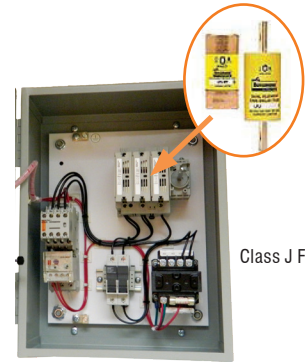

Class J Fuses

Some customers have expressed a desire to buy fusible combination motor starters with Type J power fuses installed in the motor starter. Dealers want and need power fuses installed at Sprecher + Schuh; so, they won't have to open packaging in order to install power fuses provided by others.

#### 230V Series CATN7 with Fusible Disconnect (J Type) with Power Fuses ②③④

NEMA Size	Max HP 3-Phase ①	Adjustment Range	Fuse Clip AMPS	Fuse Size	Type 1 (M1) Metallic General Purpose	D I M	Type 3R (M3) Metallic Outdoor Raintight	D I M
					Catalog Number		⑤ Catalog Number	
00	0.25	0.2...1.0	30	1.8	CATN7-12-XB-1EBB-JF1.8G17-L11	C	CATN7-12-XB-1EBB-JF1.8G17-L11	0
	0.5	1.0...5.0	30	3.5	CATN7-12-XB-1ECB-JF3.5G17-L11	C	CATN7-12-XB-1ECB-JF3.5G17-L11	0
	0.75	1.0...5.0	30	5	CATN7-12-XB-1ECB-JF5G17-L11	C	CATN7-12-XB-1ECB-JF5G17-L11	0
	1	1.0...5.0	30	6.25	CATN7-12-XB-1ECB-JF6.25G17-L11	C	CATN7-12-XB-1ECB-JF6.25G17-L11	0
	1.5	3.2...16	30	9	CATN7-12-XB-1EDB-JF9G17-L11	C	CATN7-12-XB-1EDB-JF9G17-L11	0
0	2	3.2...16	30	10	CATN7-16-XB-1EDB-JF10G17-L11	C	CATN7-16-XB-1EDB-JF10G17-L11	0
	3	3.2...16	30	15	CATN7-16-XB-1EDB-JF15G17-L11	C	CATN7-16-XB-1EDB-JF15G17-L11	0
1	5	5.4...27	30	25	CATN7-37-XB-1EED-JF25G17-L11	C	CATN7-37-XB-1EED-JF25G17-L11	0
	7.5	5.4...27	60	35	CATN7-37-XB-1EED-JF35G17-L11	C	CATN7-37-XB-1EED-JF35G17-L11	0
2	10	11...55	60	40	CATN7-43-XB-1EFD-JF40G17-L11	C	CATN7-43-XB-1EFD-JF40G17-L11	0
	15	11...55	60	70	CATN7-43-XB-1EFD-JF70G17-L11	C	CATN7-43-XB-1EFD-JF70G17-L11	0
3	20	20...100	100	80	CATN7-85-XB-1EGE-JF80G17-L11	D3	CATN7-85-XB-1EGE-JF80G17-L11	0
	25	20...100	100	100	CATN7-85-XB-1EGE-JF100G17-L11	D3	CATN7-85-XB-1EGE-JF100G17-L11	0
	30	20...100	200	125	CATN7-85-XB-1EGE-JF125G17-L11	G	CATN7-85-XB-1EGE-JF125G17-L11	T

#### Full Voltage Non-Reversing (FVNR) Features include:

- NEMA-sized CAN7 contactor
- CEP7 Electronic Overload Relay
- Control Circuit Transformer
- Hand-Off-Auto (H-O-A) selector switch
- Red Run pilot light
- 2-NO and 1-NC auxiliaries for customer use
- Class CC Fuse holder as fused primary of CCT
- UL98 fusible L11 disconnect and included with set of line power fuses
- Reset pushbutton

① HP and NEMA size selection for line voltages shown. Contact your Sprecher + Schuh representative for other voltage application.

② Contactors are equipped with 2 NO and 1 NC auxiliary contact standard. See Modification Section to order additional or different auxiliary contacts.

③ Fusible combo starter uses the L11 Disconnect. Fuse clips accept "J" type fuses. Power fuses are supplied with this specific assembly.

④ A Red and Yellow Handle may be selected instead of the standard Black handle. Change "JF" to "LF" in catalog number.

⑤ Dimensional information starts on page C122.

### Series CATN7 460V AC with Fusible Disconnect (J-Type) ③④

NEMA Size	Max HP 3-Phase ①	Adjustment Range	Fuse Clip AMPS	Type 1 Metallic General Purpose	D I M	Type 3R Metallic Outdoor Raintight	D I M
	460V			Catalog No.		⑤ Catalog No.	
00	0.25	0.2...1.0	30	CATN7-12-XC-1EBB-JF61G17-L11	C	CATN7-12-XC-1EBB-JF61R17-L11	0
	0.5	1.0...5.0	30	CATN7-12-XC-1ECB-JF61G17-L11	C	CATN7-12-XC-1ECB-JF61R17-L11	0
	0.75	1.0...5.0	30	CATN7-12-XC-1ECB-JF61G17-L11	C	CATN7-12-XC-1ECB-JF61R17-L11	0
	1	1.0...5.0	30	CATN7-12-XC-1ECB-JF61G17-L11	C	CATN7-12-XC-1ECB-JF61R17-L11	0
	1.5	1.0...5.0	30	CATN7-12-XC-1ECB-JF61G17-L11	C	CATN7-12-XC-1ECB-JF61R17-L11	0
0	2	1.0...5.0	30	CATN7-12-XC-1ECB-JF61G17-L11	C	CATN7-12-XC-1ECB-JF61R17-L11	0
	3	3.2...16	30	CATN7-16-XC-1EDB-JF61G17-L11	C	CATN7-16-XC-1EDB-JF61R17-L11	0
1	5	3.2...16	30	CATN7-16-XC-1EDB-JF61G17-L11	C	CATN7-16-XC-1EDB-JF61R17-L11	0
	7.5	5.4...27	30	CATN7-37-XC-1EED-JF61G17-L11	C	CATN7-37-XC-1EED-JF61R17-L11	0
2	10	5.4...27	30	CATN7-37-XC-1EED-JF61G17-L11	C	CATN7-37-XC-1EED-JF61R17-L11	0
	15	11...55	60	CATN7-43-XC-1EFD-JF62G17-L11	C	CATN7-43-XC-1EFD-JF62R17-L11	0
	20	11...55	60	CATN7-43-XC-1EFD-JF62G17-L11	C	CATN7-43-XC-1EFD-JF62R17-L11	0
3	25	11...55	60	CATN7-43-XC-1EFD-JF62G17-L11	C	CATN7-43-XC-1EFD-JF62R17-L11	0
	30	20...100	60	CATN7-85-XC-1EGE-JF62G17-L11	D3	CATN7-85-XC-1EGE-JF62R17-L11	0
	40	20...100	100	CATN7-85-XC-1EGE-JF63G17-L11	D3	CATN7-85-XC-1EGE-JF63R17-L11	0
	50	20...100	100	CATN7-85-XC-1EGE-JF63G17-L11	D3	CATN7-85-XC-1EGE-JF63R17-L11	0

#### Full Voltage Non-Reversing (FVNR) Features include:

- NEMA-sized CAN7 contactor
- CEP7 Electronic Overload Relay
- Control Circuit Transformer
- Hand-Off-Auto (H-O-A) selector switch
- Red Run pilot light
- 2-NO and 1-NC auxiliaries for customer use
- Class CC Fuse holder as fused primary of CCT
- UL98 fusible L11 disconnect
- Reset pushbutton

### Series CATN7 575V AC with Fusible Disconnect (J-Type) ③④

NEMA Size	Max HP 3-Phase ①	Adjustment Range	Fuse Clip AMPS	Type 1 Metallic General Purpose	D I M	Type 3R Metallic Outdoor Raintight	D I M
	575V			Catalog No.		⑤ Catalog No.	
00	0.25	0.2...1.0	30	CATN7-12-XD-1EBB-JF61G17-L11	C	CATN7-12-XD-1EBB-JF61R17-L11	0
	0.5	1.0...5.0	30	CATN7-12-XD-1ECB-JF61G17-L11	C	CATN7-12-XD-1ECB-JF61R17-L11	0
	0.75	1.0...5.0	30	CATN7-12-XD-1ECB-JF61G17-L11	C	CATN7-12-XD-1ECB-JF61R17-L11	0
	1	1.0...5.0	30	CATN7-12-XD-1ECB-JF61G17-L11	C	CATN7-12-XD-1ECB-JF61R17-L11	0
	2	1.0...5.0	30	CATN7-12-XD-1ECB-JF61G17-L11	C	CATN7-12-XD-1ECB-JF61R17-L11	0
0	3	3.2...16	30	CATN7-16-XD-1EDB-JF61G17-L11	C	CATN7-16-XD-1EDB-JF61R17-L11	0
	5	3.2...16	30	CATN7-16-XD-1EDB-JF61G17-L11	C	CATN7-16-XD-1EDB-JF61R17-L11	0
1	7.5	5.4...27	30	CATN7-37-XD-1EED-JF61G17-L11	C	CATN7-37-XD-1EED-JF61R17-L11	0
	10	5.4...27	30	CATN7-37-XD-1EED-JF61G17-L11	C	CATN7-37-XD-1EED-JF61R17-L11	0
2	15	11...55	30	CATN7-43-XD-1EFD-JF61G17-L11	C	CATN7-43-XD-1EFD-JF61R17-L11	0
	20	11...55	60	CATN7-43-XD-1EFD-JF62G17-L11	C	CATN7-43-XD-1EFD-JF62R17-L11	0
	25	11...55	60	CATN7-43-XD-1EFD-JF62G17-L11	C	CATN7-43-XD-1EFD-JF62R17-L11	0
3	30	20...100	60	CATN7-85-XD-1EGE-JF62G17-L11	D3	CATN7-85-XD-1EGE-JF62R17-L11	0
	40	20...100	60	CATN7-85-XD-1EGE-JF62G17-L11	D3	CATN7-85-XD-1EGE-JF62R17-L11	0
	50	20...100	100	CATN7-85-XD-1EGE-JF63G17-L11	D3	CATN7-85-XD-1EGE-JF63R17-L11	0

- ① HP and NEMA size selection for line voltages shown. Contact your Sprecher + Schuh representative for other voltage application.
- ② Contactors are equipped with 2 NO and 1 NC auxiliary contacts standard. See page C108 to order additional or different auxiliary contacts.
- ③ Fusible combo starter uses the L11 Disconnect. Fuse clips accept "J" type fuses. Power fuses not supplied.
- ④ A Red and Yellow Handle may be selected instead of the standard Black handle. Change "JF" to "LF" in catalog number.
- ⑤ Dimensional information starts on page C122.

#### 460V Series CATN7 with Fusible Disconnect (J Type) ②③④

NEMA Size	Max HP 3-Phase ①	Adjustment Range	Fuse Clip Amps	Fuse Size	Type 1 (M1) Metallic General Purpose	D I M	Type 3R (M3) Metallic Outdoor Raintight	D I M
					Catalog Number		⑤ Catalog Number	
00	0.25	0.2...1.0	30	1	CATN7-12-XC-1EBB-JF1G17-L11	C	CATN7-12-XC-1EBB-JF1R17-L11	0
	0.5	1.0...5.0	30	1.6	CATN7-12-XC-1ECB-JF1.6G17-L11	C	CATN7-12-XC-1ECB-JF1.6R17-L11	0
	0.75	1.0...5.0	30	2.25	CATN7-12-XC-1ECB-JF2.25G17-L11	C	CATN7-12-XC-1ECB-JF2.25R17-L11	0
	1	1.0...5.0	30	3.2	CATN7-12-XC-1ECB-JF3.2G17-L11	C	CATN7-12-XC-1ECB-JF3.2R17-L11	0
	1.5	1.0...5.0	30	4.5	CATN7-12-XC-1ECB-JF4.5G17-L11	C	CATN7-12-XC-1ECB-JF4.5R17-L11	0
	2	3.2...16	30	5	CATN7-12-XC-1EDB-JF5G17-L11	C	CATN7-12-XC-1EDB-JF5R17-L11	0
0	3	3.2...16	30	8	CATN7-16-XC-1EDB-JF8G17-L11	C	CATN7-16-XC-1EDB-JF8R17-L11	0
	5	3.2...16	30	12	CATN7-16-XC-1EDB-JF12G17-L11	C	CATN7-16-XC-1EDB-JF12R17-L11	0
1	7.5	5.4...27	30	17.5	CATN7-37-XC-1EED-JF17.5G17-L11	C	CATN7-37-XC-1EED-JF17.5R17-L11	0
	10	5.4...27	30	20	CATN7-37-XC-1EED-JF20G17-L11	C	CATN7-37-XC-1EED-JF20R17-L11	0
2	15	11...55	60	35	CATN7-43-XC-1EFD-JF35G17-L11	C	CATN7-43-XC-1EFD-JF35R17-L11	0
	20	11...55	60	40	CATN7-43-XC-1EFD-JF40G17-L11	C	CATN7-43-XC-1EFD-JF40R17-L11	0
	25	11...55	60	50	CATN7-43-XC-1EFD-JF50G17-L11	C	CATN7-43-XC-1EFD-JF50R17-L11	0
3	30	20...100	60	60	CATN7-85-XC-1EGE-JF60G17-L11	D3	CATN7-85-XC-1EGE-JF60R17-L11	0
	40	20...100	100	80	CATN7-85-XC-1EGE-JF80G17-L11	D3	CATN7-85-XC-1EGE-JF80R17-L11	0
	50	20...100	100	100	CATN7-85-XC-1EGE-JF100G17-L11	D3	CATN7-85-XC-1EGE-JF100R17-L11	0

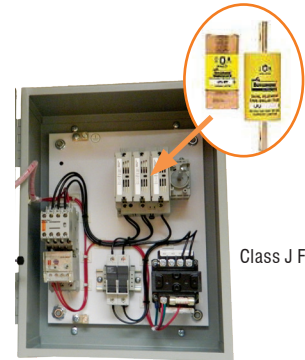

Some customers have expressed a desire to buy fusible combination motor starters with Type J power fuses installed in the motor starter. Dealers want and need power fuses installed at Sprecher + Schuh; so, they won't have to open packaging in order to install power fuses provided by others.

#### 575V Series CATN7 with Fusible Disconnect (J Type) ②③④

NEMA Size	Max HP 3-Phase ①	Adjustment Range	Fuse Clip Amp	Fuse Size	Type 1 (M1) Metallic General Purpose	D I M	Type 3R (M3) Metallic Outdoor Raintight	D I M
					Catalog Number		⑤ Catalog Number	
00	0.25	0.2...1.0	30	1	CATN7-12-XD-1EBB-JF1G17-L11	C	CATN7-12-XD-1EBB-JF1R17-L11	0
	0.5	1.0...5.0	30	1.5	CATN7-12-XD-1ECB-JF1.5G17-L11	C	CATN7-12-XD-1ECB-JF1.5R17-L11	0
	0.75	1.0...5.0	30	2	CATN7-12-XD-1ECB-JF2G17-L11	C	CATN7-12-XD-1ECB-JF2R17-L11	0
	1	1.0...5.0	30	2.8	CATN7-12-XD-1ECB-JF2.8G17-L11	C	CATN7-12-XD-1ECB-JF2.8R17-L11	0
	1.5	1.0...5.0	30	3.5	CATN7-12-XD-1ECB-JF3.5G17-L11	C	CATN7-12-XD-1ECB-JF3.5R17-L11	0
	2	1.0...5.0	30	4	CATN7-12-XD-1ECB-JF4G17-L11	C	CATN7-12-XD-1ECB-JF4R17-L11	0
0	3	3.2...16	30	6	CATN7-16-XD-1EDB-JF6G17-L11	C	CATN7-16-XD-1EDB-JF6R17-L11	0
	5	3.2...16	30	10	CATN7-16-XD-1EDB-JF10G17-L11	C	CATN7-16-XD-1EDB-JF10R17-L11	0
1	7.5	5.4...27	30	15	CATN7-37-XD-1EED-JF15G17-L11	C	CATN7-37-XD-1EED-JF15R17-L11	0
	10	5.4...27	30	17.5	CATN7-37-XD-1EED-JF17.5G17-L11	C	CATN7-37-XD-1EED-JF17.5R17-L11	0
2	15	11...55	30	25	CATN7-43-XD-1EFD-JF25G17-L11	C	CATN7-43-XD-1EFD-JF25R17-L11	0
	20	11...55	60	35	CATN7-43-XD-1EFD-JF35G17-L11	C	CATN7-43-XD-1EFD-JF35R17-L11	0
	25	11...55	60	40	CATN7-43-XD-1EFD-JF40G17-L11	C	CATN7-43-XD-1EFD-JF40R17-L11	0
3	30	20...100	60	50	CATN7-85-XD-1EGE-JF50G17-L11	D3	CATN7-85-XD-1EGE-JF50R17-L11	0
	40	20...100	60	60	CATN7-85-XD-1EGE-JF60G17-L11	D3	CATN7-85-XD-1EGE-JF60R17-L11	0
	50	20...100	100	80	CATN7-85-XD-1EGE-JF80G17-L11	D3	CATN7-85-XD-1EGE-JF80R17-L11	0

#### Full Voltage Non-Reversing (FVNR) Features include:

- NEMA-sized CAN7 contactor
- CEP7 Electronic Overload Relay
- Control Circuit Transformer
- Hand-Off-Auto (H-O-A) selector switch
- Red Run pilot light
- 2-NO and 1-NC auxiliaries for customer use
- Class CC Fuse holder as fused primary of CCT
- UL98 fusible L11 disconnect and included with set of line power fuses
- Reset pushbutton

- ① HP and NEMA size selection for line voltages shown. Contact your Sprecher + Schuh representative for other voltage application.
- ② Contactors are equipped with 2 NO and 1 NC auxiliary contacts standard. See page C108 to order additional or different auxiliary contacts.
- ③ Fusible combo starter uses the L11 Disconnect. Fuse clips accept "J" type fuses. Power fuses are supplied with this specific assembly.
- ④ A Red and Yellow Handle may be selected instead of the standard Black handle. Change "JF" to "LF" in catalog number.
- ⑤ Dimensional information starts on page C122.

### Series CATN7 with Non-Fusible Disconnect ③④

NEMA Size	Maximum Horsepower Three Phase				Disc Size/Amps	Type 1 General Purpose	D I M	Type 12 [Type 3R ②] Industrial Dusttight	D I M
	200V	230V	460V	575V		Catalog No.		① Catalog No.	
00	1.5	1.5	2	2	30	CATN7-12-*◆-JU61G0	C	CATN7-12-*◆-JU61D0	C2
0	3	3	5	5	30	CATN7-16-*◆-JU61G0	C	CATN7-16-*◆-JU61D0	C2
1	5	7.5	10	10	30	CATN7-37-*◆-JU61G0	C	CATN7-37-*◆-JU61D0	C2
	7.5	~	~	~	60	CATN7-37-*◆-JU62G0	C	CATN7-37-*◆-JU62D0	C2
2	~	~	15	15	30	CATN7-43-*◆-JU61G0	C	CATN7-43-*◆-JU61D0	C2
	10	15	25	25	60	CATN7-43-*◆-JU62G0	C	CATN7-43-*◆-JU62D0	C2
3	15	~	30	40	60	CATN7-85-*◆-JU62G0	D3	CATN7-85-*◆-JU62D0	Q
	25	30	50	50	100	CATN7-85-*◆-JU63G0	D3	CATN7-85-*◆-JU63D0	Q

### Series CATN7 with Non-Fusible Disconnect ③④

NEMA Size	Maximum Horsepower Three Phase				Disc Size/Amps	Type 4 Watertight	D I M	Type 4X Watertight Corrosion Resistant Non-metallic	D I M
	200V	230V	460V	575V		Catalog No.		① Catalog No.	
00	1.5	1.5	2	2	30	CATN7-12-*◆-JU61W0	Q	CATN7-12-*◆-JU61C0	V1
0	3	3	5	5	30	CATN7-16-*◆-JU61W0	Q	CATN7-16-*◆-JU61C0	V1
1	5	7.5	10	10	30	CATN7-37-*◆-JU61W0	Q	CATN7-37-*◆-JU61C0	V1
	7.5	~	~	~	60	CATN7-37-*◆-JU62W0	Q	CATN7-37-*◆-JU62C0	V1
2	~	~	15	15	30	CATN7-43-*◆-JU61W0	Q	CATN7-43-*◆-JU61C0	V1
	10	15	25	25	60	CATN7-43-*◆-JU62W0	Q	CATN7-43-*◆-JU62C0	V1
3	15	~	30	40	60	CATN7-85-*◆-JU62W0	Q	CATN7-85-*◆-JU62C0	W2
	25	30	50	50	100	CATN7-85-*◆-JU63W0	Q	CATN7-85-*◆-JU63C0	W2

**NOTE:** Catalog numbers and enclosure dimensions reflect contactors with AC coils. For DC coils, select Coil Code from the DC Coil Code table on page C104 and follow the instructions for modifying catalog numbers.

### Ordering Instructions

Specify Catalog Number	
Replace (*) with Coil Code	See page C104 See pages C105-C106 See pages C107-C111
Replace (◆) with O/L Relay	
Factory Modifications available	

- ① Dimensional information starts on page C122.
- ② For Type 3R outdoor applications, replace "D" in catalog number with an "R". Dimensions may change. For example number CATN7-16-\*◆-JU61D0 becomes CATN7-16-\*◆-JU61R0. Price remains the same.
- ③ Non-fusible combo-starter uses the L11 Non-Fusible Disconnect.
- ④ A Red and Yellow Handle may be selected instead of the standard Black handle. Change "JU" to "LU" in catalog number.

### Series CATN7 @208V AC with Non-Fusible Disconnect ②③④

NEMA Size	Max HP 3-Phase ①	Adjustment Range	Disc Size/ Amps	Type 1 Metallic General Purpose	D I M	Type 3R Metallic Outdoor Raintight	D I M
				Catalog No.		⑥	
00	0.25	0.2...1.0	30	CATN7-12-XA-1EBB-JU61G17-L11	C	CATN7-12-XA-1EBB-JU61R17-L11	0
	0.5	1.0...5.0	30	CATN7-12-XA-1ECB-JU61G17-L11	C	CATN7-12-XA-1ECB-JU61R17-L11	0
	0.75	1.0...5.0	30	CATN7-12-XA-1ECB-JU61G17-L11	C	CATN7-12-XA-1ECB-JU61R17-L11	0
	1	1.0...5.0	30	CATN7-12-XA-1ECB-JU61G17-L11	C	CATN7-12-XA-1ECB-JU61R17-L11	0
	1.5	3.2...16	30	CATN7-12-XA-1EDB-JU61G17-L11	C	CATN7-12-XA-1EDB-JU61R17-L11	0
0	2	3.2...16	30	CATN7-16-XA-1EDB-JU61G17-L11	C	CATN7-16-XA-1EDB-JU61R17-L11	0
	3	3.2...16	30	CATN7-16-XA-1EDB-JU61G17-L11	C	CATN7-16-XA-1EDB-JU61R17-L11	0
1	5	5.4...27	30	CATN7-37-XA-1EED-JU61G17-L11	C	CATN7-37-XA-1EED-JU61R17-L11	0
	7.5	5.4...27	30	CATN7-37-XA-1EED-JU61G17-L11	C	CATN7-37-XA-1EED-JU61R17-L11	0
2	10	11...55	60	CATN7-43-XA-1EFD-JU62G17-L11	C	CATN7-43-XA-1EFD-JU62R17-L11	0
3	15	20...100	60	CATN7-85-XA-1EGE-JU62G17-L11	D3	CATN7-85-XA-1EGE-JU62R17-L11	0
	20	20...100	100	CATN7-85-XA-1EGE-JU63G17-L11	D3	CATN7-85-XA-1EGE-JU63R17-L11	0
	25	20...100	100	CATN7-85-XA-1EGE-JU63G17-L11	D3	CATN7-85-XA-1EGE-JU63R17-L11	0

#### Full Voltage Non-Reversing (FVNR) Features include:

- NEMA-sized CAN7 contactor
- CEP7 Electronic Overload Relay
- Control Circuit Transformer
- Hand-Off-Auto (H-O-A) selector switch
- Red Run pilot light
- 2-NO and 1-NC auxiliaries for customer use
- Class CC Fuse holder as fused primary of CCT
- UL98 non-fusible L11 disconnect switch
- Reset pushbutton

1.0...5.0

### Series CATN7 @230V AC with Non-Fusible Disconnect ②③④

NEMA Size	Max HP 3-Phase ⑥	Adjustment Range	Disc Size/ Amps	Type 1 Metallic General Purpose	D I M	Type 3R Metallic Outdoor Raintight	D I M
				Catalog No.		⑥	
00	0.25	0.2...1.0	30	CATN7-12-XB-1EBB-JU61G17-L11	C	CATN7-12-XB-1EBB-JU61R17-L11	0
	0.5	1.0...5.0	30	CATN7-12-XB-1ECB-JU61G17-L11	C	CATN7-12-XB-1ECB-JU61R17-L11	0
	0.75	1.0...5.0	30	CATN7-12-XB-1ECB-JU61G17-L11	C	CATN7-12-XB-1ECB-JU61R17-L11	0
	1	1.0...5.0	30	CATN7-12-XB-1ECB-JU61G17-L11	C	CATN7-12-XB-1ECB-JU61R17-L11	0
	1.5	1.0...5.0	30	CATN7-12-XB-1ECB-JU61G17-L11	C	CATN7-12-XB-1ECB-JU61R17-L11	0
0	2	3.2...16	30	CATN7-16-XB-1EDB-JU61G17-L11	C	CATN7-16-XB-1EDB-JU61R17-L11	0
	3	3.2...16	30	CATN7-16-XB-1EDB-JU61G17-L11	C	CATN7-16-XB-1EDB-JU61R17-L11	0
1	5	5.4...27	30	CATN7-37-XB-1EED-JU61G17-L11	C	CATN7-37-XB-1EED-JU61R17-L11	0
	7.5	5.4...27	30	CATN7-37-XB-1EED-JU61G17-L11	C	CATN7-37-XB-1EED-JU61R17-L11	0
2	10	11...55	60	CATN7-43-XB-1EFD-JU62G17-L11	C	CATN7-43-XB-1EFD-JU62R17-L11	0
	15	11...55	60	CATN7-43-XB-1EFD-JU62G17-L11	C	CATN7-43-XB-1EFD-JU62R17-L11	0
3	20	20...100	100	CATN7-85-XB-1EGE-JU63G17-L11	D3	CATN7-85-XB-1EGE-JU63R17-L11	0
	25	20...100	100	CATN7-85-XB-1EGE-JU63G17-L11	D3	CATN7-85-XB-1EGE-JU63R17-L11	0
	30	20...100	100	CATN7-85-XB-1EGE-JU63G17-L11	D3	CATN7-85-XB-1EGE-JU63R17-L11	0

① HP and NEMA size selection shown for 208V ratings only. Contact your Sprecher + Schuh representative for other voltage application.

② Contactors are equipped with 2 NO and 1 NC auxiliary contacts standard. See page C108 to order additional or different auxiliary contacts.

③ Fusible combo starter uses the L11 Disconnect. Fuse clips accept "J" type fuses. Power fuses not supplied.

④ A Red and Yellow Handle may be selected instead of the standard Black handle. Change "JF" to "LF" in catalog number.

⑥ HP and NEMA size selection shown for 230V ratings only. Contact your Sprecher + Schuh representative for other voltage application.

⑦ Dimensional information starts on page C122.

### Series CATN7 @460V AC with Non-Fusible Disconnect ②③④

NEMA Size	Max HP 3-Phase ①	Adjustment Range	Disc Size/ Amps	Type 1 Metallic General Purpose	D I M	Type 3R Metallic Outdoor Raintight	D I M
				Catalog No.		⑥	
00	0.25	0.2...1.0	30	CATN7-12-XC-1EBB-JU61G17-L11	C	CATN7-12-XC-1EBB-JU61R17-L11	0
	0.5	1.0...5.0	30	CATN7-12-XC-1ECB-JU61G17-L11	C	CATN7-12-XC-1ECB-JU61R17-L11	0
	0.75	1.0...5.0	30	CATN7-12-XC-1ECB-JU61G17-L11	C	CATN7-12-XC-1ECB-JU61R17-L11	0
	1	1.0...5.0	30	CATN7-12-XC-1ECB-JU61G17-L11	C	CATN7-12-XC-1ECB-JU61R17-L11	0
	1.5	1.0...5.0	30	CATN7-12-XC-1ECB-JU61G17-L11	C	CATN7-12-XC-1ECB-JU61R17-L11	0
	2	1.0...5.0	30	CATN7-12-XC-1ECB-JU61G17-L11	C	CATN7-12-XC-1ECB-JU61R17-L11	0
0	3	3.2...16	30	CATN7-16-XC-1EDB-JU61G17-L11	C	CATN7-16-XC-1EDB-JU61R17-L11	0
	5	3.2...16	30	CATN7-16-XC-1EDB-JU61G17-L11	C	CATN7-16-XC-1EDB-JU61R17-L11	0
1	7.5	5.4...27	30	CATN7-37-XC-1EED-JU61G17-L11	C	CATN7-37-XC-1EED-JU61R17-L11	0
	10	5.4...27	30	CATN7-37-XC-1EED-JU61G17-L11	C	CATN7-37-XC-1EED-JU61R17-L11	0
2	15	11...55	30	CATN7-43-XC-1EFD-JU61G17-L11	C	CATN7-43-XC-1EFD-JU61R17-L11	0
	20	11...55	60	CATN7-43-XC-1EFD-JU62G17-L11	C	CATN7-43-XC-1EFD-JU62R17-L11	0
	25	11...55	60	CATN7-43-XC-1EFD-JU62G17-L11	C	CATN7-43-XC-1EFD-JU62R17-L11	0
	30	20...100	60	CATN7-85-XC-1EGE-JU62G17-L11	D3	CATN7-85-XC-1EGE-JU62R17-L11	0
3	40	20...100	100	CATN7-85-XC-1EGE-JU63G17-L11	D3	CATN7-85-XC-1EGE-JU63R17-L11	0
	50	20...100	100	CATN7-85-XC-1EGE-JU63G17-L11	D3	CATN7-85-XC-1EGE-JU63R17-L11	0

**Full Voltage Non-Reversing (FVNR) Features include:**

- NEMA-sized CAN7 contactor
- CEP7 Electronic Overload Relay
- Control Circuit Transformer
- Hand-Off-Auto (H-O-A) selector switch
- Red Run pilot light
- 2-NO and 1-NC auxiliaries for customer use
- Class CC Fuse holder as fused primary of CCT
- UL98 non-fusible L11 disconnect switch
- Reset pushbutton

**C**  
NEMA Starters

### Series CATN7 @575V AC with Non-Fusible Disconnect ②③④

NEMA Size	Max HP 3-Phase ①	Adjustment Range	Disc Size/ Amps	Type 1 Metallic General Purpose	D I M	Type 3R Metallic Outdoor Raintight	D I M
				Catalog No.		⑥	
00	0.25	0.2...1.0	30	CATN7-12-XD-1EBB-JU61G17-L11	C	CATN7-12-XD-1EBB-JU61R17-L11	0
	0.5	1.0...5.0	30	CATN7-12-XD-1ECB-JU61G17-L11	C	CATN7-12-XD-1ECB-JU61R17-L11	0
	0.75	1.0...5.0	30	CATN7-12-XD-1ECB-JU61G17-L11	C	CATN7-12-XD-1ECB-JU61R17-L11	0
	1	1.0...5.0	30	CATN7-12-XD-1ECB-JU61G17-L11	C	CATN7-12-XD-1ECB-JU61R17-L11	0
	2	1.0...5.0	30	CATN7-12-XD-1ECB-JU61G17-L11	C	CATN7-12-XD-1ECB-JU61R17-L11	0
	0	3	3.2...16	30	CATN7-16-XD-1EDB-JU61G17-L11	C	CATN7-16-XD-1EDB-JU61R17-L11
5		3.2...16	30	CATN7-16-XD-1EDB-JU61G17-L11	C	CATN7-16-XD-1EDB-JU61R17-L11	0
1	7.5	5.4...27	30	CATN7-37-XD-1EED-JU61G17-L11	C	CATN7-37-XD-1EED-JU61R17-L11	0
	10	5.4...27	30	CATN7-37-XD-1EED-JU61G17-L11	C	CATN7-37-XD-1EED-JU61R17-L11	0
2	15	11...55	30	CATN7-43-XD-1EFD-JU61G17-L11	C	CATN7-43-XD-1EFD-JU61R17-L11	0
	20	11...55	30	CATN7-43-XD-1EFD-JU61G17-L11	C	CATN7-43-XD-1EFD-JU61R17-L11	0
	25	11...55	60	CATN7-43-XD-1EFD-JU62G17-L11	C	CATN7-43-XD-1EFD-JU62R17-L11	0
	30	20...100	60	CATN7-85-XD-1EGE-JU62G17-L11	D3	CATN7-85-XD-1EGE-JU62R17-L11	0
3	40	20...100	60	CATN7-85-XD-1EGE-JU62G17-L11	D3	CATN7-85-XD-1EGE-JU62R17-L11	0
	50	20...100	100	CATN7-85-XD-1EGE-JU63G17-L11	D3	CATN7-85-XD-1EGE-JU63R17-L11	0

- ① HP and NEMA size selection shown for 460V ratings only. Contact your Sprecher + Schuh representative for other voltage application.
- ② Contactors are equipped with 2 NO and 1 NC auxiliary contacts standard. See page Cam almost done but it has been a struggle all day C108 to order additional or different auxiliary contacts.
- ③ Fusible combo starter uses the L11 Disconnect. Fuse clips accept "J" type fuses. Power fuses not supplied.
- ④ A Red and Yellow Handle may be selected instead of the standard Black handle. Change "JF" to "LF" in catalog number.
- ⑤ HP and NEMA size selection shown for 575V ratings only. Contact your Sprecher + Schuh representative for other voltage application.
- ⑥ Dimensional information starts on page C122.

# Fireman Damper Interface for HVAC Starters

Sprecher + Schuh's fireman and damper control interface option is exclusively for HVAC markets. These options are offered in a single package modification to our standard Non-Combination or Combination starters.

## Bundled Features

The Fireman and Damper interface modification is available in two control voltages; 24V or 120V AC. The selection of 24V (-FD24) or 120V AC (-FD120) for the control circuit is dependent on the damper motor control voltage and fireman override voltage which matches the control power transformer secondary (if CPT is provided). The fireman and damper modification is easily added with a simple -FD24 or -FD120 to the end of the catalog number. The control circuit voltage must be specified at the time of order entry and is not field changeable. The modifications are fully integrated and factory installed for a ready-to-use starter.

The Fireman-Damper option allows for interface with electrically operated dampers where motorized dampers must be opened before the blower motor is allowed to start. This option also accommodates a contact input from a damper limit switch to signal that the motorized damper is in fact open. An end switch for analog interface with the motorized damper would be provided by others. The run permissive option includes provision for a second remote control device which is useful if the blower is initiated from two remote control devices like a thermostat and a CO<sub>2</sub> sensor. The emergency shutdown feature allows for two wire connection to two terminal blocks from a remote device like an E-Stop pushbutton. This bundle of features includes a Fireman Override which will accept a two-wire powered signal from a fire control system in a remote control room. This Fireman Override feature might be used to exhaust smoke out

of a building in case of fire. Use of the Fireman Override causes the damper to open and the blower to run regardless what state the other controls one in including if Off is selected on the H-O-A switch. In case of an actual fire the Fireman Override by-passes the overload relay protection and will run the motor to destruction or the overload by-pass can be disabled for periodic testing of the override circuit. 22mm incandescent pilot lights provide clear visual indication of the mode of operation and status – no squinting to see tiny LEDs'. All the bundled options are factory wired and includes jumpers for normal operation. Until the jumper is removed and the optional remote device(s) are wired into place. This means complete flexibility to use only some or all of the features included.

## Standard Features

- Shutdown Input – Customer provides a normally closed dry contact which enables the starter until the shutdown button or E-stop is depressed which opens the contact and the blower starter is disabled in the Hand or Auto mode (except in Fireman's override).
- Damper Motor – Provides a 24 or 120 VAC output as specified to actuate the damper motor when the blower starter is either in the Hand or Auto mode. This option includes a connection for a customer provided end switch, which enables the damper motor to engage via an analog signal.
- Damper Switch Input – Customer provides a normally open dry contact from the damper limit switch. This option prevents the blower starter from energizing until the damper is open.
- Remote Control Device (RCD) – Customer provides a normally open dry contact from the Remote Control Device which enables the blower starter in the Auto mode. (i.e.: thermostat or CO<sub>2</sub> sensor).

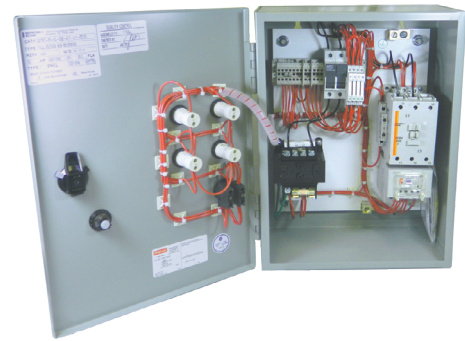

- Run Permissive – Customer provides normally closed dry contact. When the customer input contact opens the Auto mode is disabled.
- Fireman's Override – Customer provides a wet (powered) contact which energizes the damper circuit and then in turn energizes the blower motor regardless if in Hand or Auto mode, and regardless of the status of other inputs. This operation by-passes the overload relay and will run to destruction to extinguish the fire. Alternatively, a jumper can be removed for testing with the overload active in the circuit.
- Indicating lights – Four 22mm incandescent pilot lights (D7) are provided to indicate:
  - Power applied, blower motor not running (Green)
  - Auto mode selected (Blue)
  - Blower motor is running (Red)
  - Overload relay tripped (Amber)
- Factory Terminal Block Jumpers – Three factory installed terminal block jumpers are provided for shutdown, damper switch, and run permissive options which must be removed before connecting customer inputs.



C101.40



### Still a Compact Enclosed Starter

The fireman and damper option is available for combination and non-combination NEMA labeled HVAC starters in Type 1 or 3R enclosures. The -FD modification increases the size of the enclosure by only a few inches, thus maintaining the compact size Sprecher + Schuh starters are known for.

### Minimal Size Increase

Enclosure Type	D I M	Approx. Dimension without -FD option	D I M	Approx. Dimension with -FD option
<b>Non-Combination Starters</b>				
Type 1	A	10 x 8 x 6	B	12 x 10 x 6
Type 1	B	12 x 10 x 6	D3	20 x 16 x 9
Type 3R	L	8 x 6 x 6	M	10 x 8 x 6
Type 3R	M	10 x 8 x 6	Q	20 x 16 x 8
<b>Combination Starters</b>				
Type 1	C	16 x 12 x 7	D3	20 x 16 x 9
Type 1	D3 & G	Size remains the same		
Type 3R	O & T	Size remains the same		

### Catalog Numbers

Type 1 (M1) Metallic General Purpose Assembly Type	Type 3R (M3) Metallic Outdoor Raintight Assembly Type
<b>NON-COMBO</b>	
CATN7-12...43-X_-1E_-G17-L11	CATN7-12...43-X_-1E_-R17-L11
CATN7-85-X_-1EGE-G17-L11	CATN7-85-X_-1EGE-R17-L11
<b>COMBO NON-FUSIBLE</b>	
CATN7-12...43-X_-1E-JU61G17-L11	CATN7-12...43-X_-1E-JU61R17-L11
CATN7-43-X_1EFD-JU62G17-L11	CATN7-43-X_1EFD-JU62R17-L11
CATN7-85-X_-1EGE-JU62G17-L11	CATN7-85-X_-1EGE-JU62R17-L11
CATN7-85-X_-1EGE-JU63G17-L11	CATN7-85-X_-1EGE-JU63R17-L11
<b>COMBO FUSIBLE</b>	
CATN7-12...43-X_-1E_-JF61G17-L11	CATN7-12...43-X_-1E_-JF61R17-L11
CATN7-37...43-X_-1E_-JF62G17-L11	CATN7-37...43-X_-1E_-JF62R17-L11
CATN7-43-X_-1EFD-JF63G17-L11	CATN7-43-X_-1EFD-JF63R17-L11
CATN7-85-X_-1EGE-JF6217-L11	CATN7-85-X_-1EGE-JF6217-L11
CATN7-85-X_-1EGE-JF63G17-L11	CATN7-85-X_-1EGE-JF63R17-L11
CATN7-85-X_-1EGE-JF64G17-L11	CATN7-85-X_-1EGE-JF64R17-L11
<b>COMBO CIRCUIT BREAKER</b>	
CATN7-12-...43-X_-1E_-TB_G17-L11	CATN7-12-...43-X_-1E_-TB_R17-L11
CATN7-85-X_-1EGE-TB_G17-L11	CATN7-85-X_-1EGE-TB_R17-L11

**KWIKstarters excluded from -FD\* Option**

- KWIKstarters as described in the HVAC Catalog are NOT large enough to accommodate a CPT or DIN rail mounted relays and TBs; therefore cannot be considered for inclusion of the Fireman-Damper Interface options.

NEMA Starters

